



Digitized Automation for a Changing World

Delta Industrial Energy Management System DIAEnergie

www.deltaww.com

 **DELTA**
Smarter. Greener. Together.



Energy Issues

As technology development and social progress continues to move forward, we are now facing critical issues that devastate our ecosystem and accelerate the global energy crisis. Many countries and enterprises have become aware of this severe situation and the importance of energy savings, carbon emission reduction and environmental protection. They are actively looking for green energy and effective solutions.

How Can Delta **DIAEnergie** Help?

Knowing that the greatest share of power consumption is due to manufacturing industries in most countries, Delta presents the **DIAEnergie** Industrial Energy Management System to help our customers achieve real-time monitoring of the power consumption in their factories.

The **DIAEnergie** system is able to collect and analyze power usage data from different facilities in real-time, and present detailed and easy-to-read real-time or historical energy information for users or managers. It also sends warning messages to managers when abnormalities occur to achieve highly-efficient operation and management. With decades of experience in the industrial automation industry, Delta understands customer needs for real-time energy monitoring and analysis. **DIAEnergie** is an excellent tool for power efficiency enhancement on equipment and production lines, as well as building better energy strategies for users.

DIAEnergie features:

- Real-time Energy Management
- Energy Dashboard
- Energy Diagnosis, and Analysis Visualization
- Energy Performance Monitoring and Analytics
- Reports and Alarms
- Modbus and OPC Client Communication



Table of Contents

- 1 Introduction
- 3 Industrial Energy Management
DIAEnergie System
- 5 Energy-saving Management
- 5 System Structure and
Applications
- 7 Benefits and Functions
- 7 Features of DIAEnergie
- 14 Ordering Information

Smart Energy Management with DIAEnergie for Energy

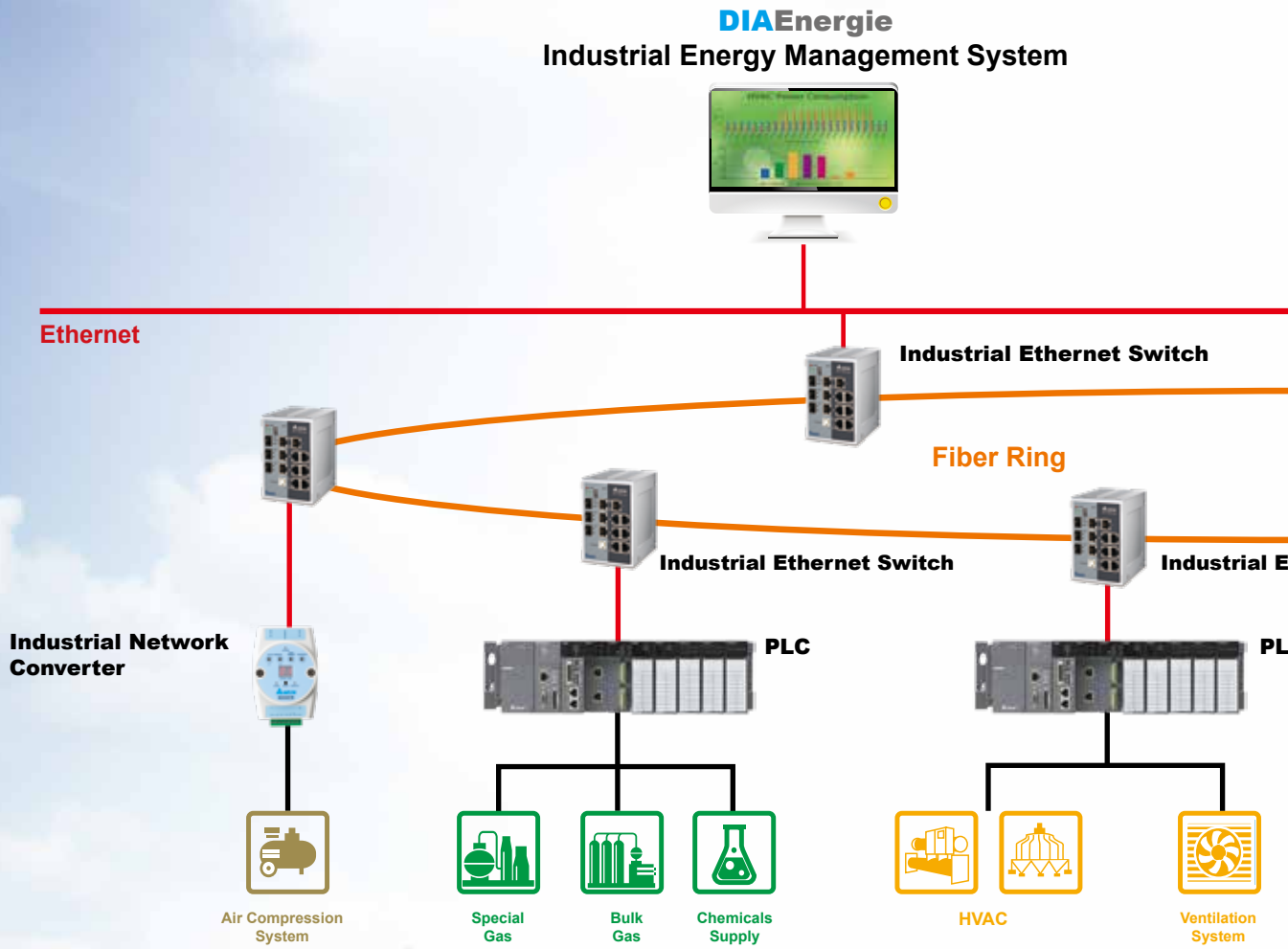

Central Control Room

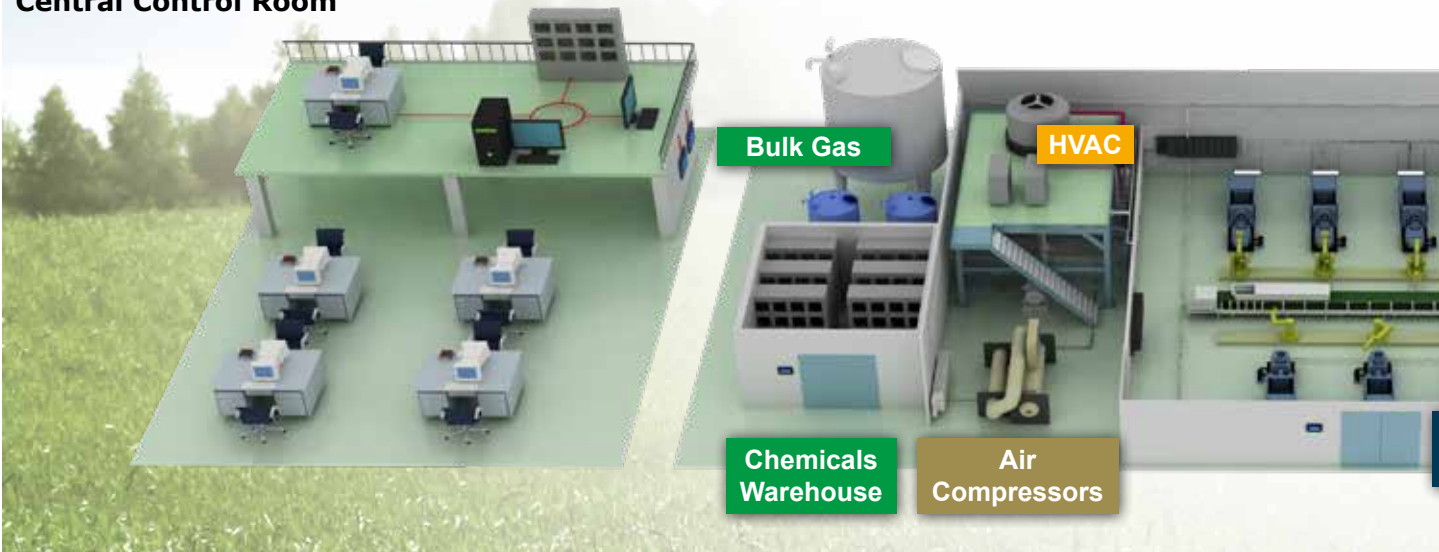

Cost Savings and Efficiency

DIAView SCADA System

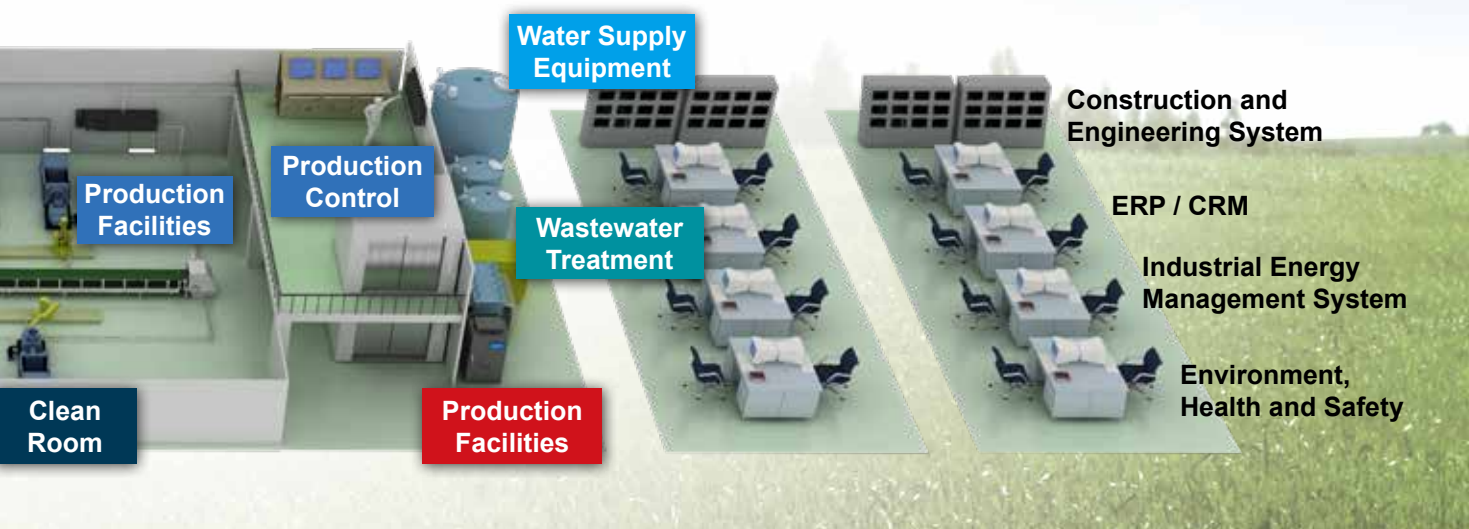
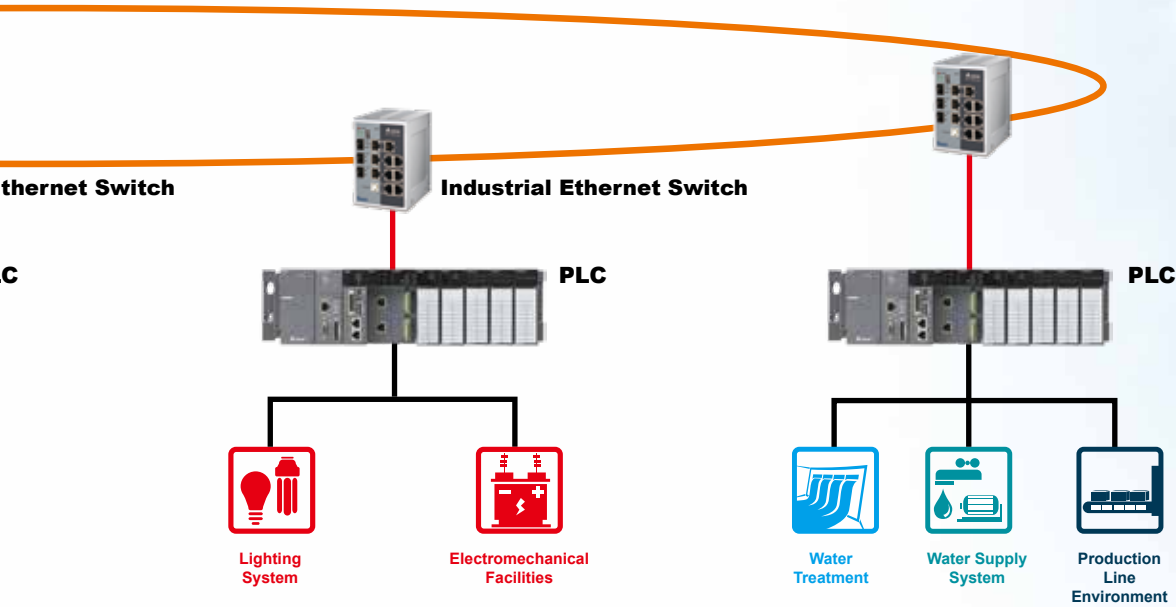

Energy Management

Determine and Diagnose Current Conditions

- Analysis of energy performance indicators (EnPI)
- Analysis of energy saving performance

Implement Solutions and Obtain Feedback

- Instant energy consumption and load characteristics analysis
- Analysis of energy consumption differentiation
- EnPI monitoring
- Reports of energy consumption data
- Alarms

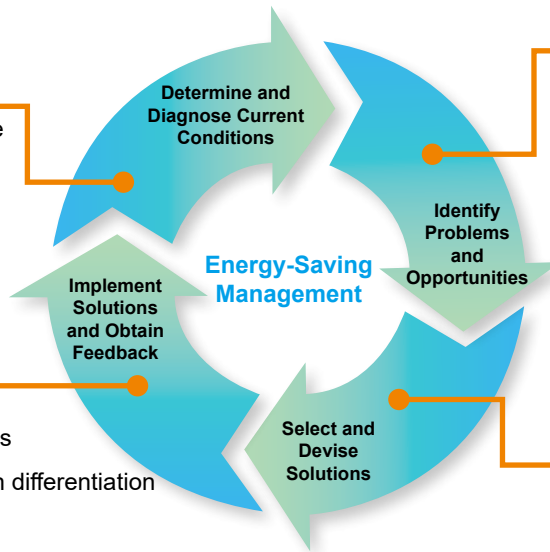

Identify Problems and Opportunities

- Ranking of energy consumption
- Analysis of energy consumption structure
- Electricity cost analysis
- Demand analysis

Select and Devise Solutions

- Establish EnPI
- Establish Energy Baseline (EB)

System Structure and Applications

Energy Management for a Single Factory

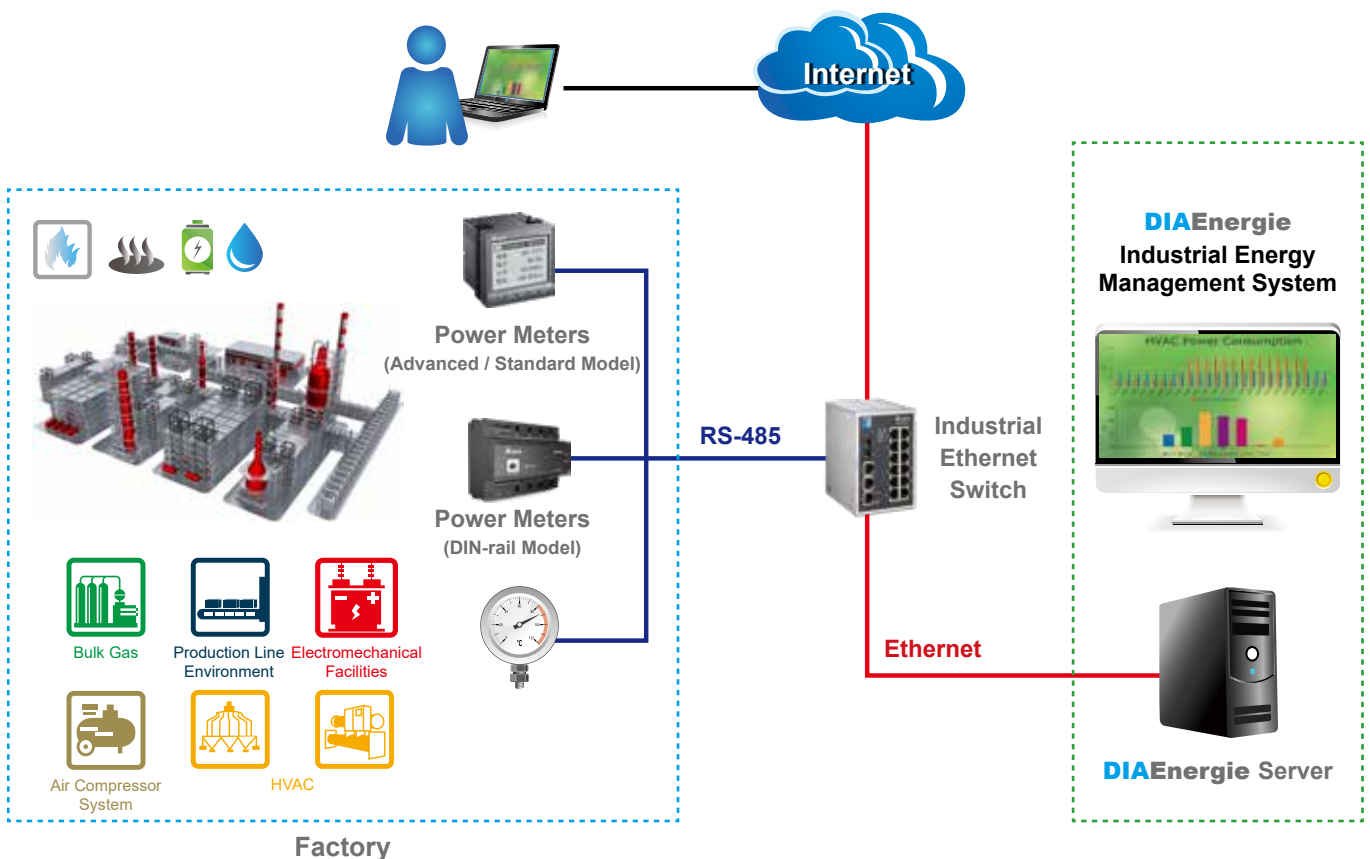

System Structure and Applications

Energy Management for Multiple Factories

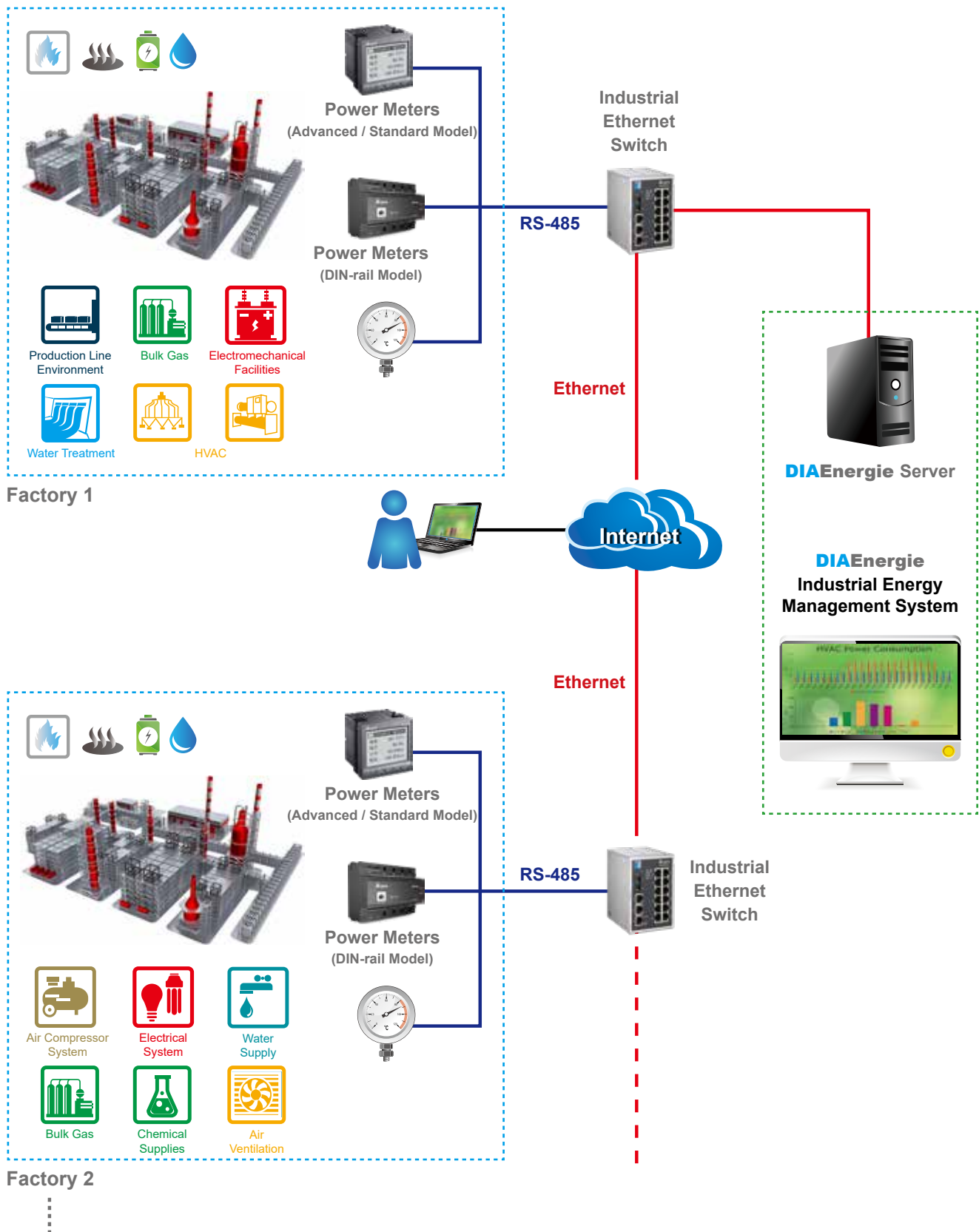

Benefits and Functions

Benefits

- Reduces energy cost
- Power usage monitoring and visualization, and abnormality detection to find more possibilities for energy savings
- Monitors equipment power efficiency and expands their service time
- Discovers reactive and excessive power consumption to avoid electricity fines
- Provides reports on energy saving and efficiency comparison for reference

Functions

- Provides measurement data analysis from various perspectives (areas, power circuits and time periods)
- Offers a variety of graphs and charts to view and analyze data quickly
- Monitors energy performance indicators of equipment
- Monitors power quality parameters
- Sends out alarms and fault messages

Features of DIAEnergie

Energy Dashboard

The energy dashboard displays significant power consumption in graphical visualization, such as alarms and more, allowing users to quickly and intuitively monitor real-time power usage conditions



Overview:

Power Usage Distribution

Diagnoses the power usage ratio of each piece of equipment by analyzing the proportion of energy consumption

Power Consumption

Lists all equipment's energy consumption to point out significant power consuming areas in the factory

Real-Time Power Demand

Displays real-time overall energy consumption to ensure reasonable power usage

Power Compare

Generates electricity statistics based on different time rates to calculate electricity costs and carbon emissions

- Easy settings to quickly build an energy dashboard
- Abundant statistical diagram tools
- Various analysis and display tools allow highly flexible usage and customization for an energy monitoring interface
- Allows background image and animation input to enrich the energy dashboard
- Auto-play function

Energy Intensity

Performs correlation analysis for production and power usage to ensure efficient electricity consumption, to achieve a balance between energy-saving and production



Alarms

Performs contrast analysis with the previous energy consumption to show the trends for each piece of energy-consuming equipment



Trends

Displays each section's overall energy consumption trend to determine correct energy-saving strategies



Notes

Flexibly edits log contents for convenient job descriptions and information transmission

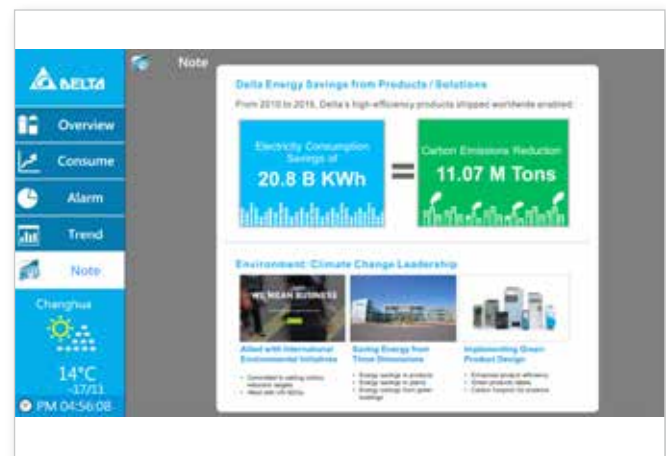

Energy Diagnosis, Visualization and Analysis

DIAEnergie provides a rich variety of charts to view energy consumption from various perspectives. It helps users realize changes in excessive energy consumption, and finds areas for energy savings.

- Analysis of regional energy consumption
- Analysis of energy consumption by different categories
- Analysis of energy consumption by different time periods
- Ranking of energy consumption
- Trends of energy consumption

Analysis of regional energy consumption

- Offers analysis view of energy consumption and power usage by equipment / area / region
- System diagnosis for abnormal power consumption or other issues

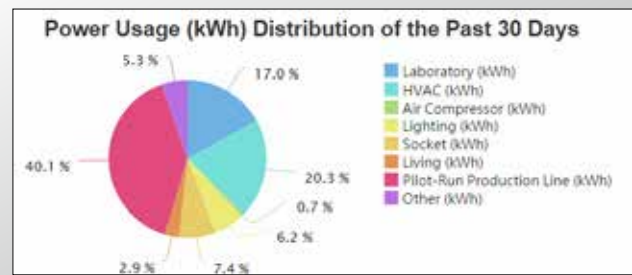

Ranking of energy consumption

- Detects excessive energy consumption
- Identifies significant power consuming equipment

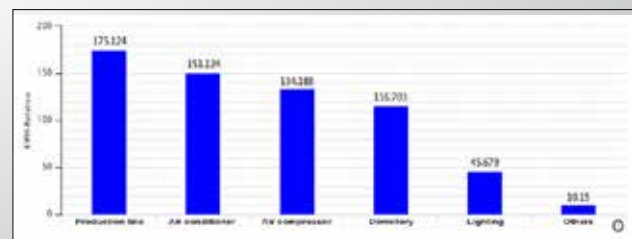

Analysis of energy consumption by different time periods

- Monitors how the power consumption of the lighting system changes during lunch breaks
- Verifies if the energy control strategy works for different time periods

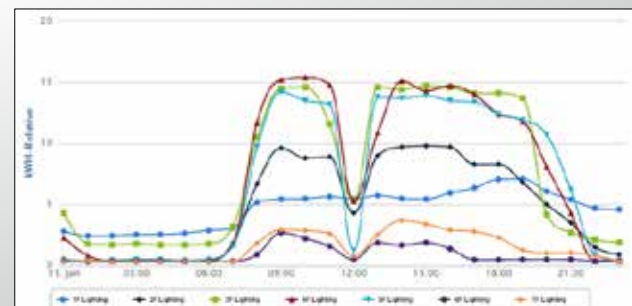

DIAEnergie collects data from different circuits, sub systems, equipment and meters to monitor various areas of energy consumption, such as electricity, water, fuel, gas and others, and generates easy-to-read reports and displays for comprehensive energy visualization, comparison and analysis.

- Comparison with the performance / increase or decrease / statistics on a month-on-month (MoM), and year-on-year (YoY) basis by energy type (electricity, water, fuel, gas and others), and by circuit / system / equipment
- Contrast analysis of previous and current periods of average energy consumption
- Contrast analysis of changes in energy consumption and key power factors such as outside air temperature, production output, working hours and others

MoM and YoY analysis by circuit, by sub system, by equipment and by energy type



Contrast analysis of previous and current period of average energy consumption

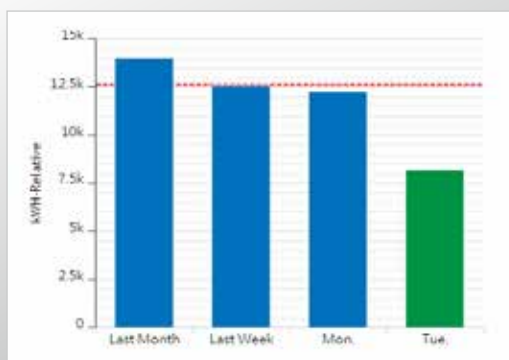

Contrast analysis of energy consumption and key power factors



Energy Performance Monitoring and Analytics

DIAEnergie allows self-defined power efficiency indices for key facilities and production processes and compares them with the indices of governmental policy, helping users to achieve energy savings.

- Equipment electricity categorization
- Real-time power output
- Accumulated energy consumption
- Energy consumption contrast analysis
- Capital and carbon emissions

Production rate of different shifts reflects production efficiency



**Energy Use Intensity (EUI)
(based on user's demands)**

Reduces power consumption of each product to save energy cost



Load factors of transformers

The transformer consumes more energy in operation at lower loads

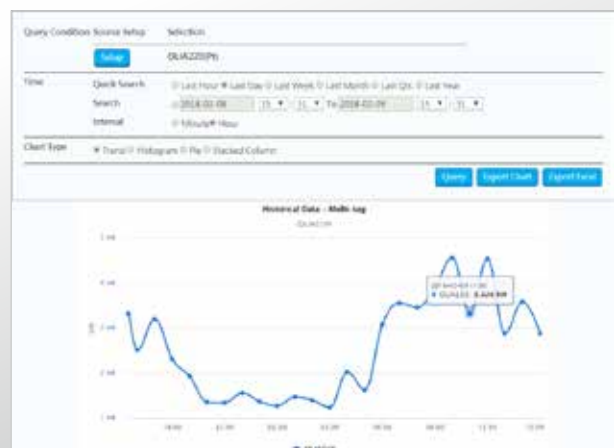

Energy Performance Analytics

Through regression analysis, DIAEnergie establishes an Energy Baseline (EB) and builds a statistical model with Energy Performance Indicators (EnPI) and affected factors, such as outdoor weather and Coefficient of Performance (COP). It presents intuitive energy efficiency enhancement and is the ideal database and reference for energy management.



Electricity Management with Time of Use Rates

Calculates electricity costs according to electricity rates by time of day, and makes adjustments to electricity usage at peak time while reducing cost.

- Electricity tariff analysis
- Electricity usage calculation at different times of day
- Electricity cost calculation for different times of day

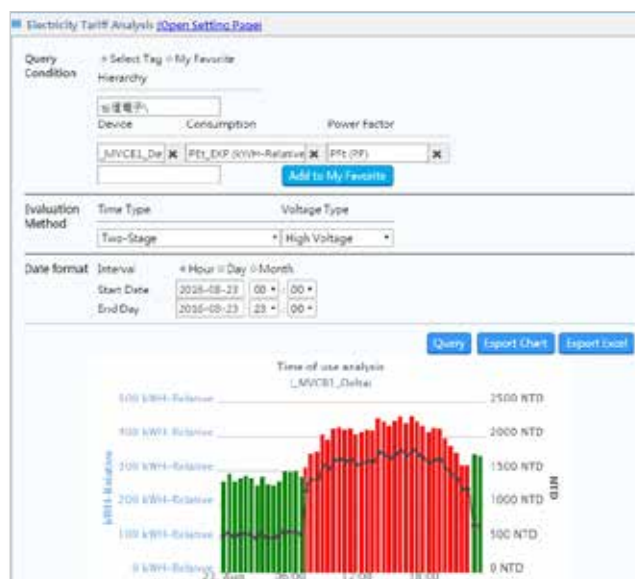

Reports

- User-defined reports
- Generates daily, weekly, monthly, quarterly and yearly reports
- Manually generates data reports
- Automatically sends reports by e-mail

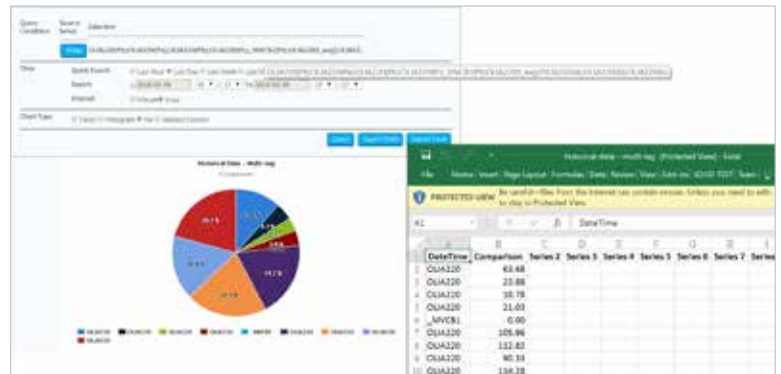

Alarms

- Maximum electricity demand
- Current capacity and energy consumption limitations
- Communication errors
- Highlights pending alarms and alarm types
- Alarm notification by e-mail to relevant operators

Standard Modbus Communication

Flexibly and quickly integrates various devices and equipment of other brands into DIAEnergie System via Modbus communication.

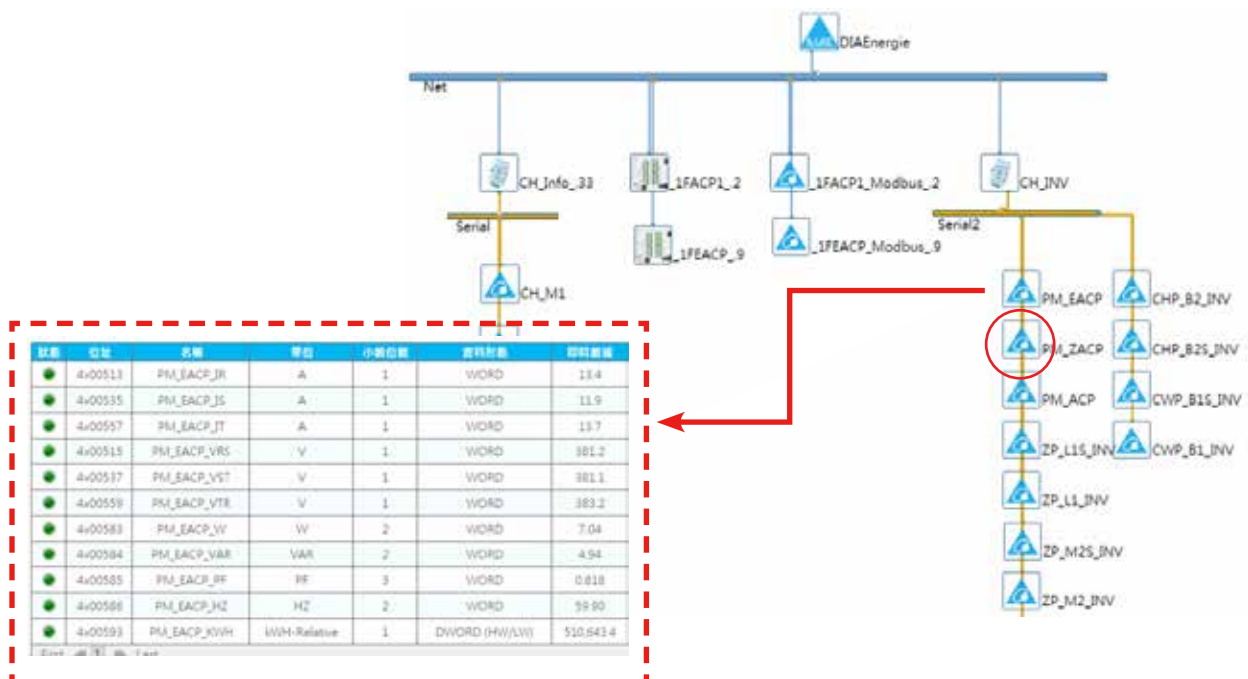

OPC Client

OPC Client protocol for easier communication and integration with third-party equipment and SCADA Systems.

Virtual Grouping Function

The virtual grouping function allows the system to categorize data from third-party devices such as PLC and the SCADA System, building a simpler and more transparent system structure.

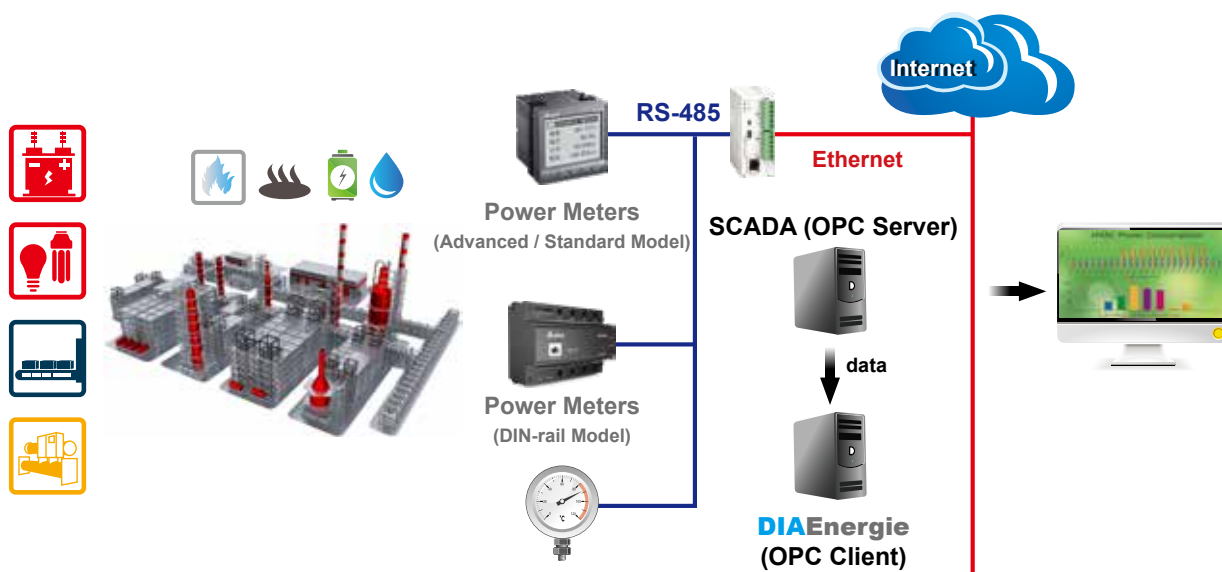

Ordering Information

Model Name	Description	Minimum System Requirements
DIAE-0201000	DIAEnergie EMS (Machine Pack) B/S version, with 10 devices or 300 tags license For machine application, license upgrade unavailable	<ul style="list-style-type: none"> ■ CPU: Intel Core i3 2.0G or above / RAM: 4G or above / Storage: 250G ■ Operating system: Windows 7 Professional (32-bit/64-bit) SP1 / Windows Server 2012 R2 or above ■ Database: Microsoft SQL Server 2008 R2(32-bit/64-bit) or above
DIAE-0102000	DIAEnergie EMS Series B/S version, with 20 devices or 600 tags license	<ul style="list-style-type: none"> ■ CPU: Intel Core i3 2.0G or above / RAM: 4G or above / Storage: 250G ■ Operating system: Windows 7 Professional (32-bit/64-bit) SP1 / Windows Server 2012 R2 or above ■ Database: Microsoft SQL Server 2008 R2(32-bit/64-bit) or above
DIAE-0105000	DIAEnergie EMS Series B/S version, with 50 devices or 1500 tags license	<ul style="list-style-type: none"> ■ CPU: Intel Core i5 2.0G or above / RAM: 8G or above / Storage: 500G ■ Operating system: Windows 7 Professional (32-bit/64-bit) SP1 / Windows Server 2012 R2 or above ■ Database: Microsoft SQL Server 2008 R2(32-bit/64-bit) or above
DIAE-0110000	DIAEnergie EMS Series B/S version, with 100 devices or 3000 tags license	<ul style="list-style-type: none"> ■ CPU: Intel Core i5 2.0G or above / RAM: 16G or above / Storage: 1TB ■ Operating system: Windows 7 Professional (32-bit/64-bit) SP1 / Windows Server 2012 R2 or above ■ Database: Microsoft SQL Server 2008 R2(32-bit/64-bit) or above
DIAE-0115000	DIAEnergie EMS Series B/S version, with 150 devices or 4500 tags license	<ul style="list-style-type: none"> ■ CPU: Intel Core i5 2.0G or above / RAM: 32G or above / Storage: 1.5TB ■ Operating system: Windows 7 Professional (32-bit/64-bit) SP1 / Windows Server 2012 R2 or above ■ Database: Microsoft SQL Server 2008 R2(32-bit/64-bit) or above
DIAE-0120000	DIAEnergie EMS Series B/S version, with 200 devices or 6000 tags license	<ul style="list-style-type: none"> ■ CPU: Intel Core i5 2.0G or above / RAM: 32G or above / Storage: 2TB ■ Operating system: Windows 7 Professional (32-bit/64-bit) SP1 / Windows Server 2012 R2 or above ■ Database: Microsoft SQL Server 2008 R2(32-bit/64-bit) or above
DIAE-0100000	DIAEnergie EMS Series B/S version, with unlimited device license	<ul style="list-style-type: none"> ■ CPU: Intel Core i7 2.0G or above / RAM: 32G or above / Storage: 10TB ■ Operating system: Windows 7 Professional (32-bit/64-bit) SP1 / Windows Server 2012 R2 or above ■ Database: Microsoft SQL Server 2008 R2(32-bit/64-bit) or above

Note :

- DIAEnergie B/S software does not include the licensed Microsoft SQL Server database.
- Maximum database size of 10 GB per database in SQL Server 2008 R2 Express.



Smarter. Greener. Together.

Industrial Automation Headquarters

Taiwan: Delta Electronics, Inc.

Taoyuan Technology Center
No.18, Xinglong Rd., Taoyuan District,
Taoyuan City 33068, Taiwan
TEL: +886-3-362-6301 / FAX: +886-3-371-6301

Asia

China: Delta Electronics (Shanghai) Co., Ltd.

No.182 Minyu Rd., Pudong Shanghai, P.R.C.
Post code : 201209
TEL: +86-21-6872-3988 / FAX: +86-21-6872-3996
Customer Service: 400-820-9595

Japan: Delta Electronics (Japan), Inc.

Industrial Automation Sales Department
2-1-14 Shibadaimon, Minato-ku
Tokyo, Japan 105-0012
TEL: +81-3-5733-1155 / FAX: +81-3-5733-1255

Korea: Delta Electronics (Korea), Inc.

1511, 219, Gasan Digital 1-Ro., Geumcheon-gu,
Seoul, 08501 South Korea
TEL: +82-2-515-5305 / FAX: +82-2-515-5302

Singapore: Delta Energy Systems (Singapore) Pte Ltd.

4 Kaki Bukit Avenue 1, #05-04, Singapore 417939
TEL: +65-6747-5155 / FAX: +65-6744-9228

India: Delta Electronics (India) Pvt. Ltd.

Plot No.43, Sector 35, HSIIDC Gurgaon,
PIN 122001, Haryana, India
TEL: +91-124-4874900 / FAX: +91-124-4874945

Thailand: Delta Electronics (Thailand) PCL.

909 Soi 9, Moo 4, Bangpoo Industrial Estate (E.P.Z),
Pattana 1 Rd., T.Phraksa, A.Muang,
Samutprakarn 10280, Thailand
TEL: +66-2709-2800 / FAX: +66-2709-2827

Australia: Delta Electronics (Australia) Pty Ltd.

Unit 20-21/45 Normanby Rd., Notting Hill Vic 3168, Australia
TEL: +61-3-9543-3720

Americas

USA: Delta Electronics (Americas) Ltd.

5101 Davis Drive, Research Triangle Park, NC 27709, U.S.A.
TEL: +1-919-767-3813 / FAX: +1-919-767-3969

Brazil: Delta Electronics Brazil

Rua Itapeva, 26 - 3º, andar Edifício Itapeva,
One - Bela Vista 01332-000 - São Paulo - SP - Brazil
TEL: +55-12-3932-2300 / FAX: +55-12-3932-237

Mexico: Delta Electronics International Mexico S.A. de C.V.

Gustavo Baz No. 309 Edificio E PB 103
Colonia La Loma, CP 54060
Tlalnepantla, Estado de México
TEL: +52-55-3603-9200

EMEA

EMEA Headquarters: Delta Electronics (Netherlands) B.V.

Sales: Sales.IA.EMEA@deltaww.com
Marketing: Marketing.IA.EMEA@deltaww.com
Technical Support: iatechnicalsupport@deltaww.com
Customer Support: Customer-Support@deltaww.com
Service: Service.IA.emea@deltaww.com
TEL: +31(0)40 800 3900

BENELUX: Delta Electronics (Netherlands) B.V.

Automotive Campus 260, 5708 JZ Helmond, The Netherlands
Mail: Sales.IA.Benelux@deltaww.com
TEL: +31(0)40 800 3900

DACH: Delta Electronics (Netherlands) B.V.

Coesterweg 45, D-59494 Soest, Germany
Mail: Sales.IA.DACH@deltaww.com
TEL: +49(0)2921 987 0

France: Delta Electronics (France) S.A.

ZI du bois Challand 2, 15 rue des Pyrénées,
Lisses, 91090 Evry Cedex, France
Mail: Sales.IA.FR@deltaww.com
TEL: +33(0)1 69 77 82 60

Iberia: Delta Electronics Solutions (Spain) S.L.U

Ctra. De Villaverde a Vallecas, 265 1º Dcha Ed.
Hormigueras – P.I. de Vallecas 28031 Madrid
TEL: +34(0)91 223 74 20

Carrer Llacuna 166, 08018 Barcelona, Spain

Mail: Sales.IA.Iberia@deltaww.com

Italy: Delta Electronics (Italy) S.r.l.

Via Meda 2-22060 Novedrate(CO)
Piazza Grazioli 18 00186 Roma Italy
Mail: Sales.IA.Italy@deltaww.com
TEL: +39 039 8900365

Russia: Delta Energy System LLC

Vereyskaya Plaza II, office 112 Vereyskaya str.
17 121357 Moscow Russia
Mail: Sales.IA.RU@deltaww.com
TEL: +7 495 644 3240

Turkey: Delta Greentech Elektronik San. Ltd. Sti. (Turkey)

Şerifali Mah. Hendem Cad. Kule Sok. No:16-A
34775 Ümraniye – İstanbul
Mail: Sales.IA.Turkey@deltaww.com
TEL: + 90 216 499 9910

MEA: Eltek Dubai (Eltek MEA DMCC)

OFFICE 2504, 25th Floor, Saba Tower 1,
Jumeirah Lakes Towers, Dubai, UAE
Mail: Sales.IA.MEA@deltaww.com
TEL: +971(0)4 2690148