

Automation for a Changing World

# Delta Robot Controller with Servo Drive Integrated ASDA-MS Series



[www.deltaww.com](http://www.deltaww.com)

 **DELTA**  
Smarter. Greener. Together.

A background image showing an industrial factory setting with various machinery, including a robotic arm and control panels, under bright overhead lights.

## **Integrated Structure, Outstanding Performance**

As a leading industrial automation brand, Delta continues to provide automated solutions for a wide range of applications and industries to fulfill customers' demands. Since industrial robots are becoming more and more important for industrial automation, Delta's industrial robot solution combines key products including controllers, AC servo drives, high-speed motion communication and a general communication interface into a real-time and highly flexible Robot Controller with Servo Drive Integrated - the ASDA-MS Series.

### **Innovative and Integrated Design**

The ASDA-MS Series integrates a robot controller and 4 axes of servo drives to perform mathematical calculations, smooth track planning, and provide loop control in one unit, greatly enhancing real-time system calculation performance. This design perfectly fulfills the demands of an industrial robots' complex non-linear system and realizes dynamic compensation to achieve high speed and high precision.

### **Complete Development Platform**

The ASDA-MS Series also supports the IEC61131-3 standard's five kinds of programming language and PLCopen motion function block. It offers Delta Robot Languages (DRL) for robot application program development, so that customers can develop customized functions and programs for applications in various industries. In addition, the ASDA-MS Series integrates peripheral devices (such as machine vision systems, sensors, and central computers) through a variety of communication interfaces, and matches extension axes via high-speed motion BUS such as Modbus and Modbus TCP to build a complete industrial robot solution.

In the competitive global market of industrial robots, Delta offers a professional industrial robot total solution to fulfill all kinds of market requirements and assist customers in improving their competitiveness and enhancing customization to provide "Automation for a Changing World".



## Table of Contents

---

- 1 Introduction
- 3 System Structure
- 4 Product Features
- 8 DRAS Software Features
- 12 Successful Applications
- 14 Ordering Information
- 18 Applicable Servo Motor List
- 19 Specifications
- 20 Exterior of the Robot Controller
- 21 Servo Motor Dimensions and Specifications
- 27 Handheld Type HMI DOP-H Series
- 29 Optional Cables and Connectors

# System Structure

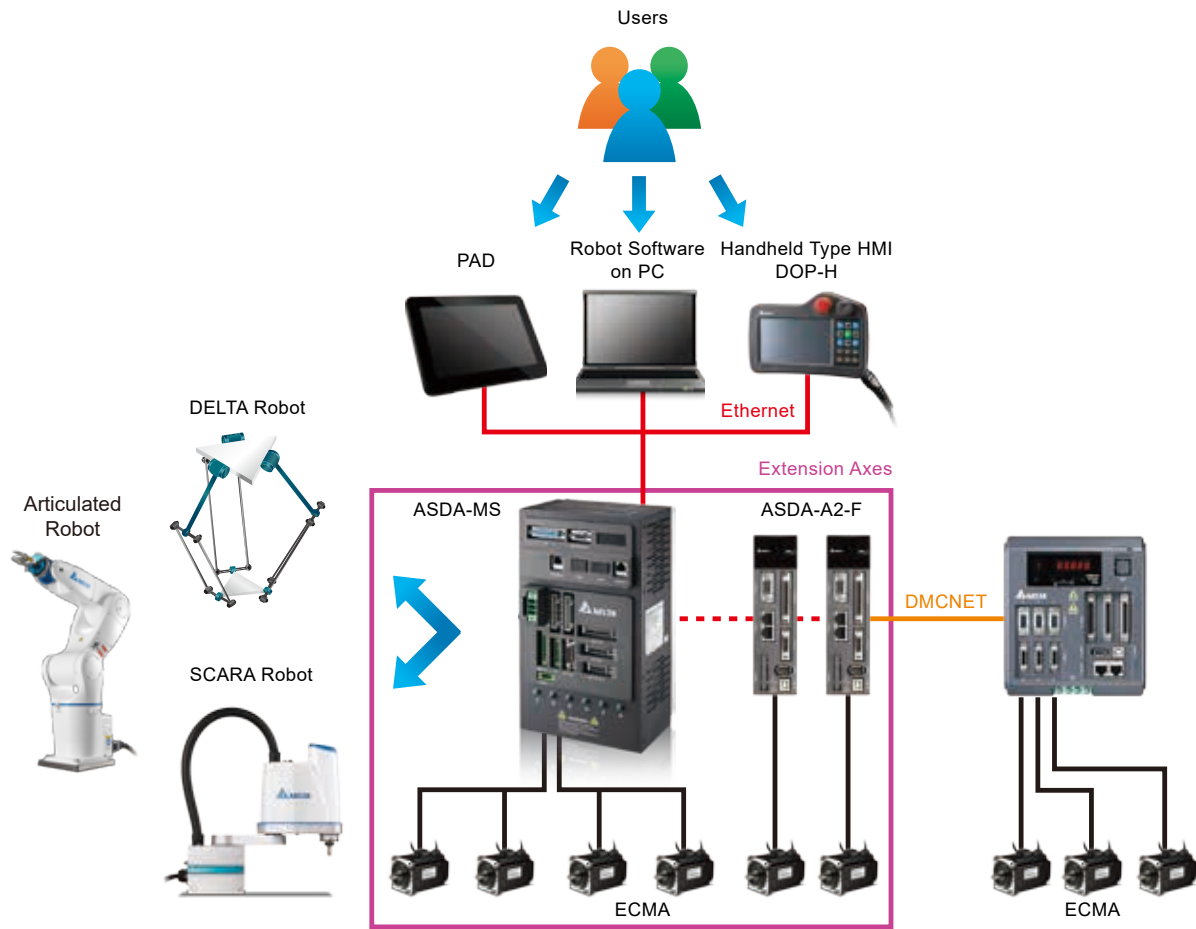

## Complete Robot Solution

- Integrates robot controller, motion controller and servo drive in one single unit with high flexibility and reliability
- Supports communication protocols for fast and smooth integration with peripheral devices
- Built-in diverse robot control modules for different applications
- Enhanced flexibility and extension with 4-axis robot and 6 external axes motion control
- Supports 5 kinds of programming languages with IEC 61131-3 standard and the PLCopen motion function block
- Offers DRL Languages for developing robot application programs and specific skill functions to fulfill customer requirements
- Supports G-code programming for path planning

## User-Friendly Robot Software

- IEC 61131-3 PLC programming
- DRL programming
- Multiple industrial robot settings
- Intelligent robot calibration
- Real-time monitoring oscilloscope
- Applicable for different types of robots such as SCARA Robots, Delta Articulated Robots and more

# Product Features

## All-in-One Robot Controller

Integrates motion controller, robot controller and 4 servo drives into one single unit to speed up data transmission, enhance system control performance and dynamically compensate non-linear terms that affect robot motion during robot moving processes, which meets the high speed and high precision requirements of robot or motion control applications.

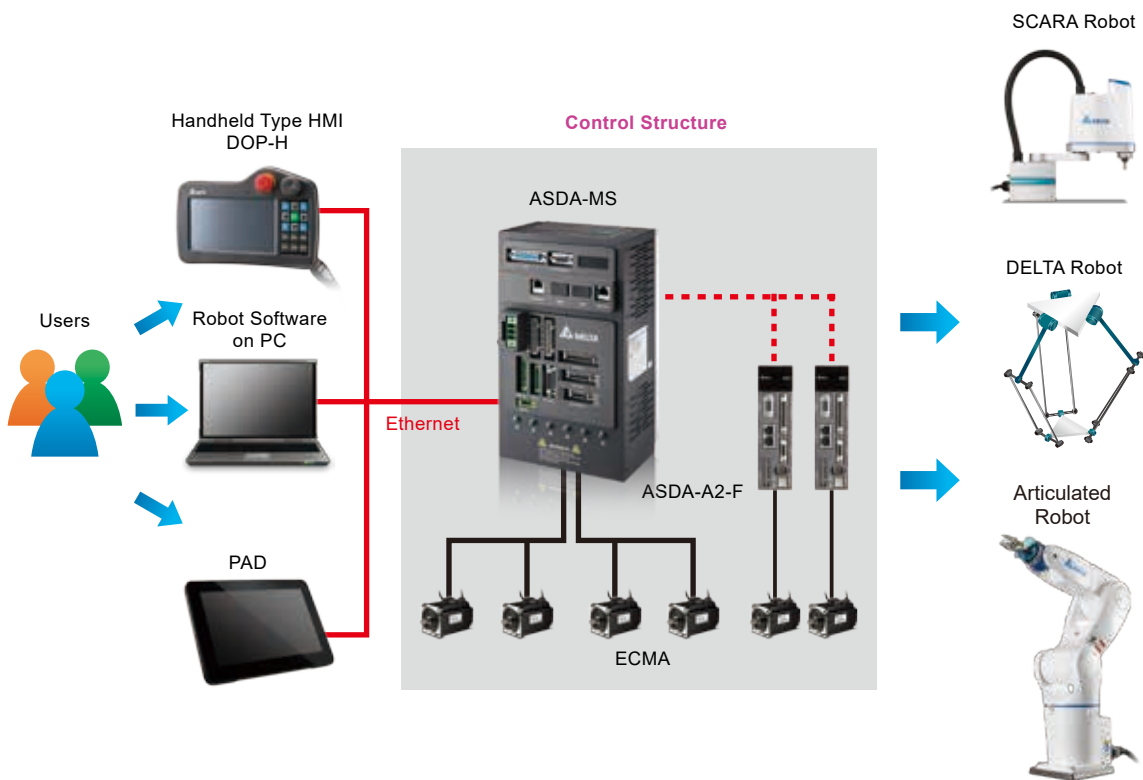

## Communication Networks for Integrated System Configuration

Supports communication protocols including Ethernet, RS-485/232 for fast integration with peripheral devices such as PLC, conveyor, DMV and other conveyor lines, offering a complete solution for information exchange with a central monitoring PC.

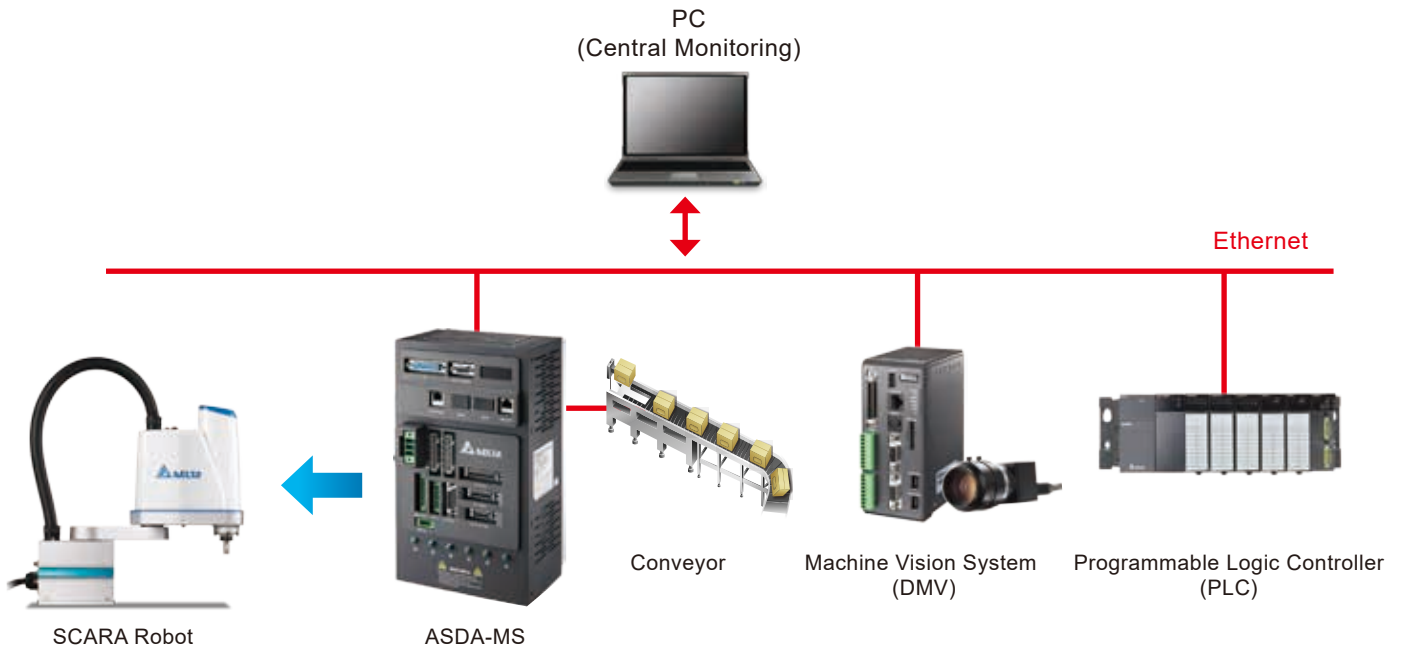

## Diverse Robot Control

Offers a variety of tools for implementing functions and supports different types of robots such as the 4-axis SCARA robot, the Linear DELTA, DELTA robot, and the 2 axes extension via DMCNET for 6-axis articulated robot to meet diverse requirements with flexibility and reliability

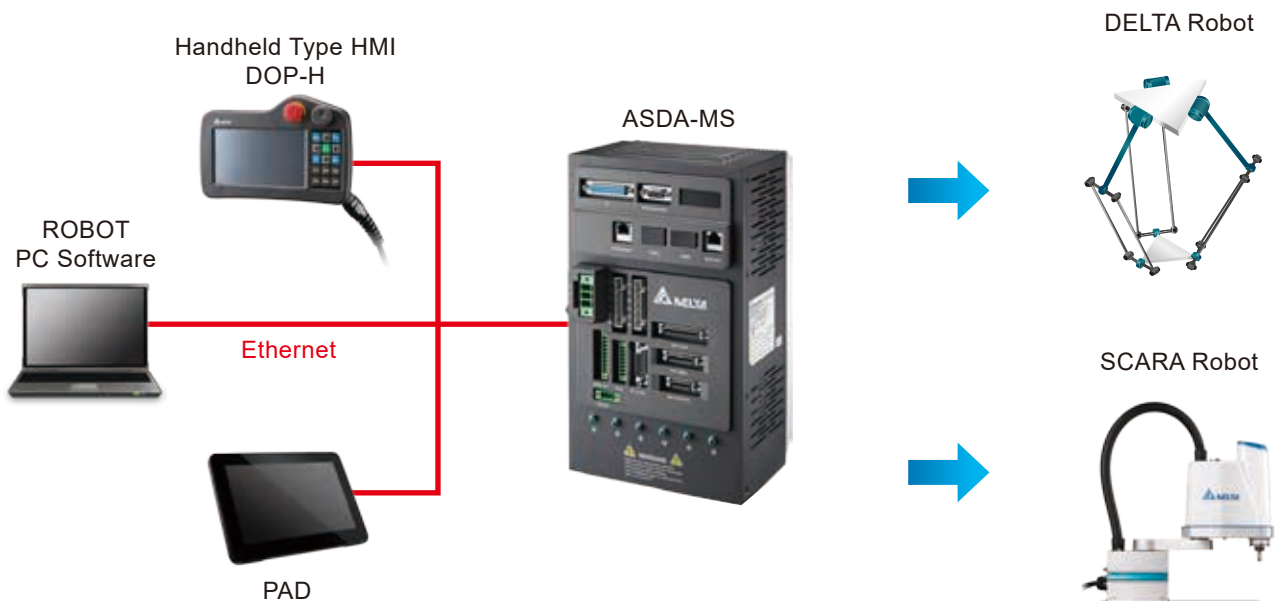

## Comprehensive Development Platform

- Provides a comprehensive development platform for customers to design their specific applications, which enhances value-added secondary development and efficiency for various manufacturing techniques
- Meets the requirements for both single robot or workstation applications integrated with Delta's industrial automation products and related robot peripheral devices to create a complete robotic automation solution

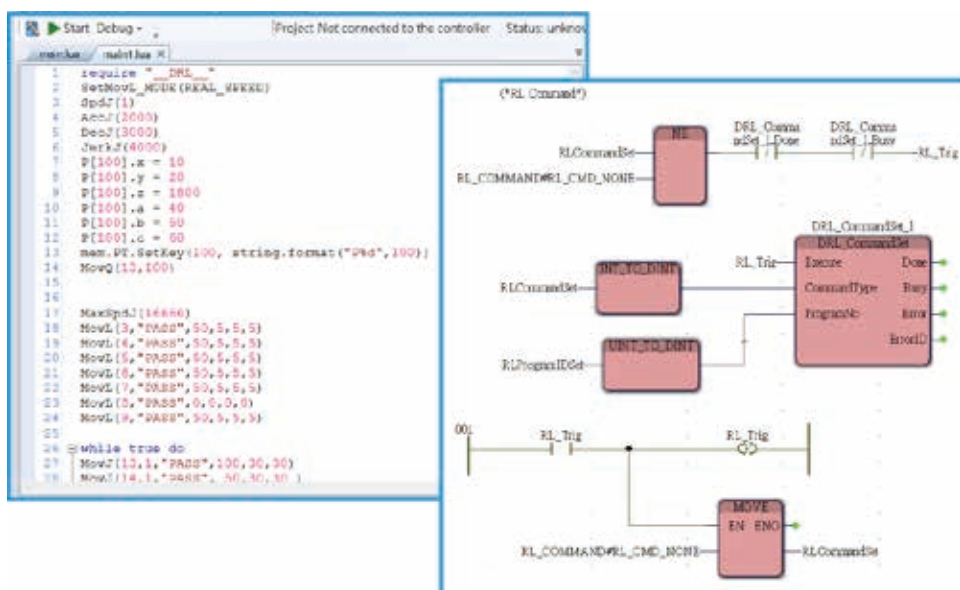
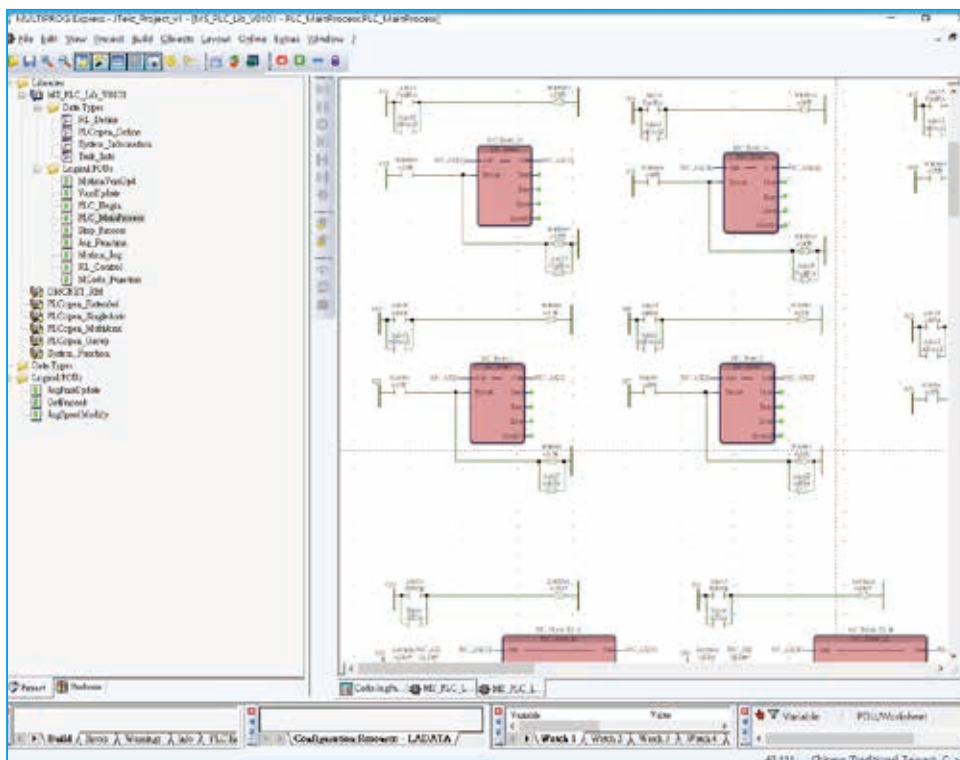

## Advanced Motion Control Functions

Featuring robot motion commands (e.g. point to point, linear, and arc), and supports G-code standard commands for CNC and other functions, the ASDA-MS Series offers the best solution with built-in optimized path control functions such as handling small path errors, fixing feed rate, and reducing path planning inaccuracy.

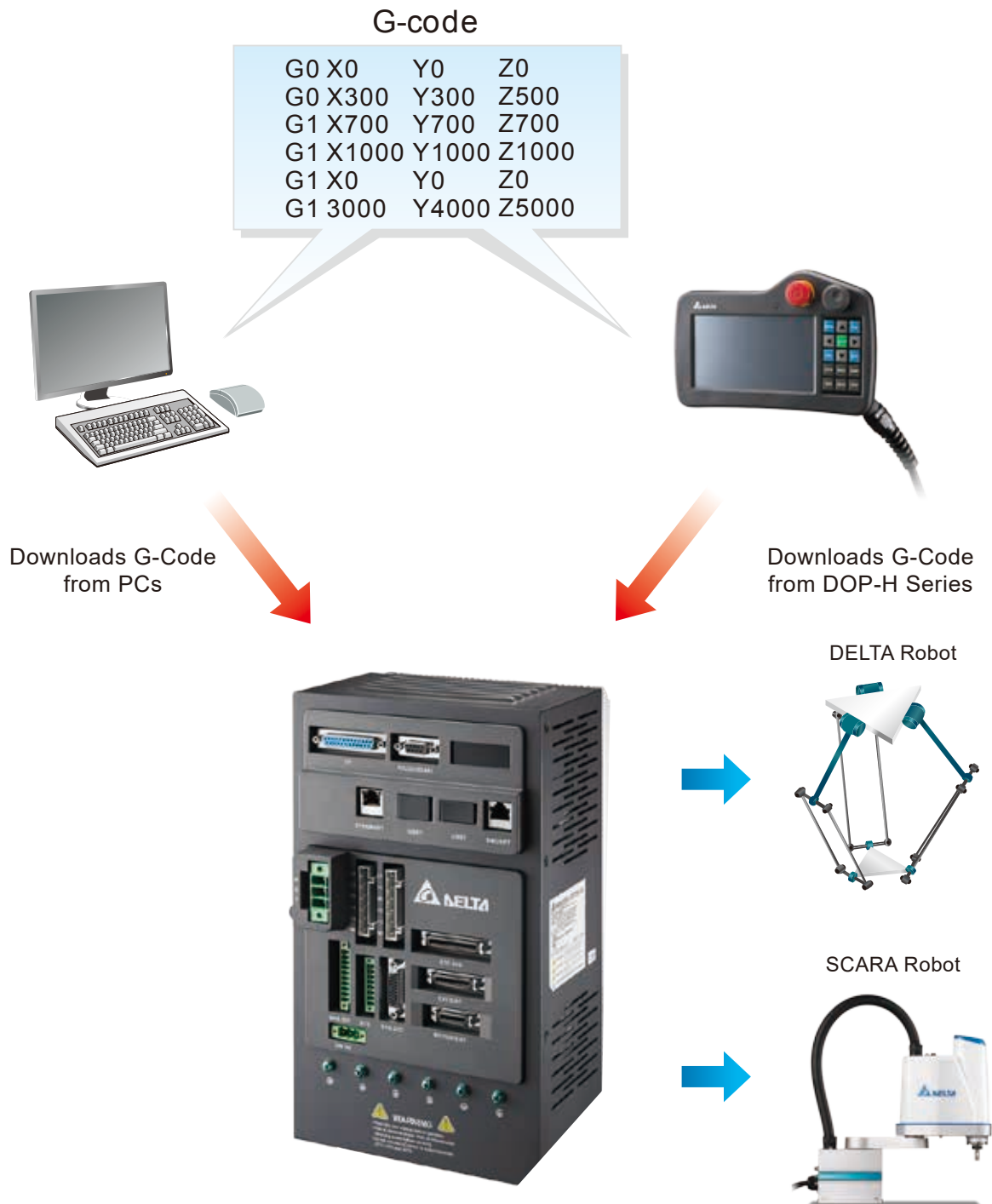



# DRAS Software (Delta Robot Automation Studio)

The DRAS Software supports five kinds of IEC 61131-3 programming languages, PLCopen motion function block, and DRL languages for developing customized robot application programs to ensure the uniqueness and completeness of individual systems.



## IEC 61131-3 PLC Programming

Supports five kinds of IEC 61131-3 programming languages and PLCopen motion function block, offering programming tools to execute techniques and functions for different applications

- LD - Ladder Diagram
- FBD – Function Block Diagram
- SFC – Sequential Function Chart
- IL- Instruction List
- ST – Structured Text

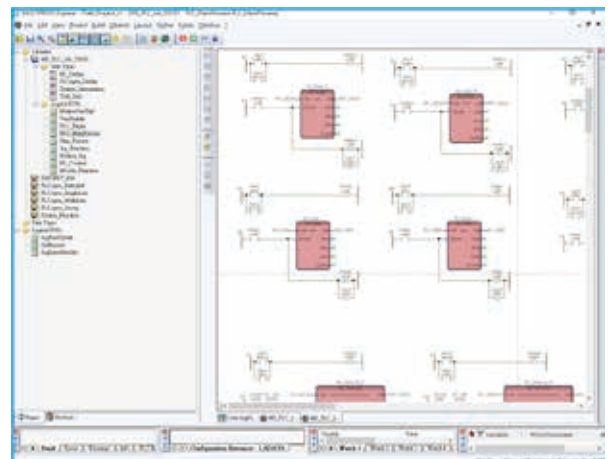

## Delta Robot Language (DRL) Programming

Provides programming development for a variety of industry applications to control industrial robots and exchange data between peripheral devices

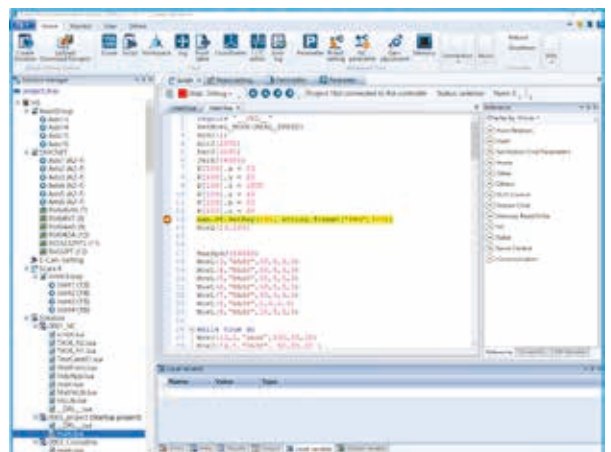

## Supports Diverse Industrial Robots

Enables real-time parameter adjustment such as gear ratio, reduction ratio, limit value and deviation of robot arm via intuitive interface design for simple operating procedures

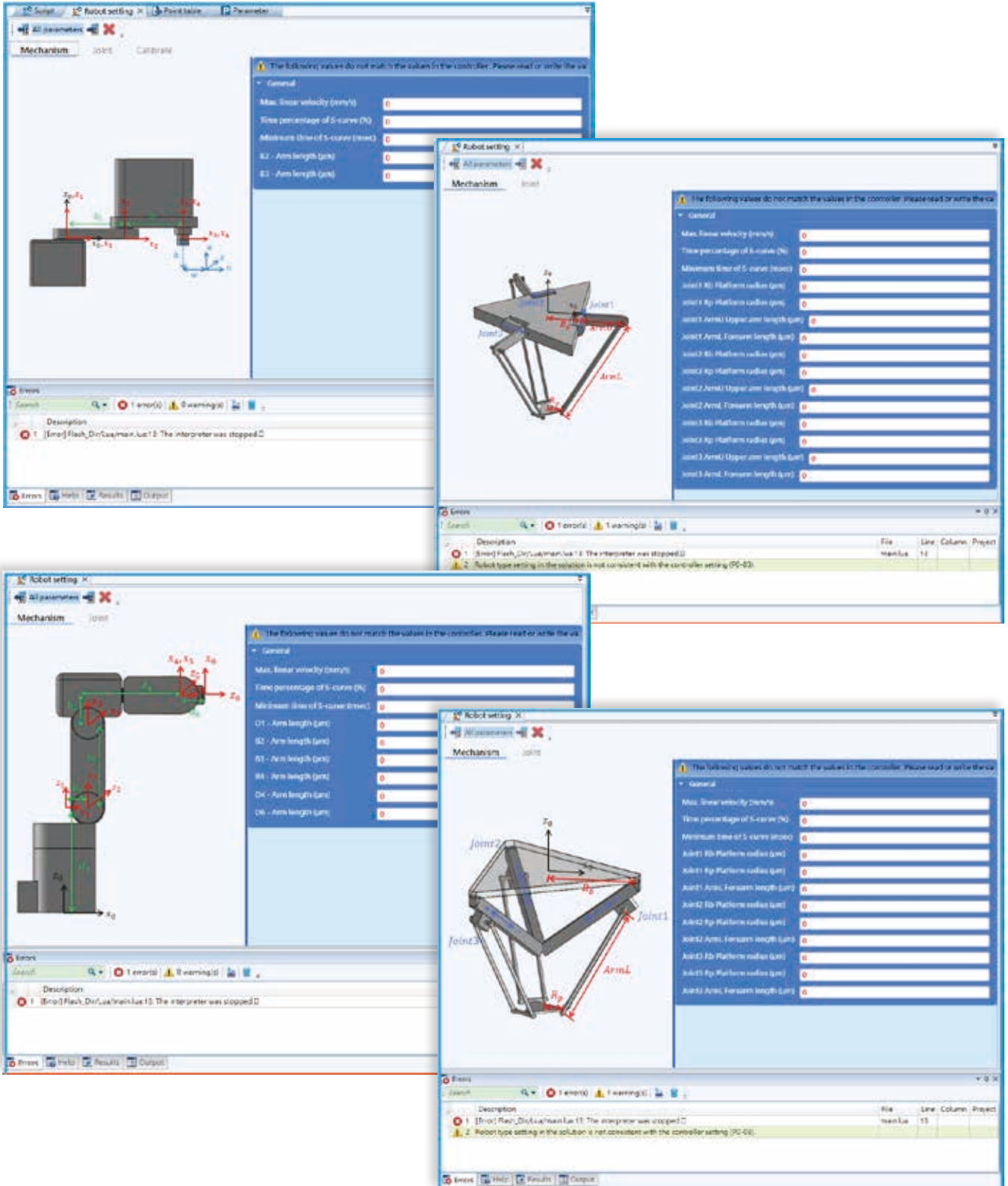

## Intelligent Robot Calibration

Allows customers to calibrate deviation of the actual device assembly based on the calibration procedure, which will automatically correct the parameters of devices to match the actual size

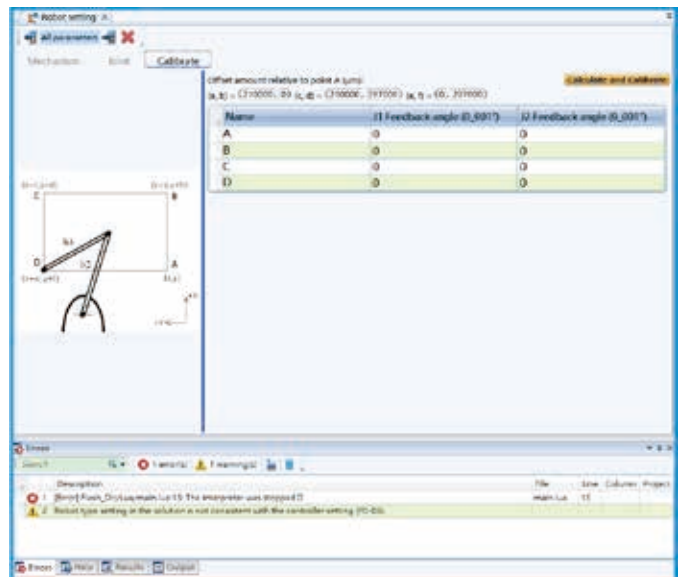

## Real-time Monitoring Oscilloscope

Assists customers in monitoring real-time information and the status of the robot arm motion process, including path planning operation, real-time analysis of system conditions and motor controlled parameters such as position, speed and current of each axis during the motion process for optimized parameter adjustment

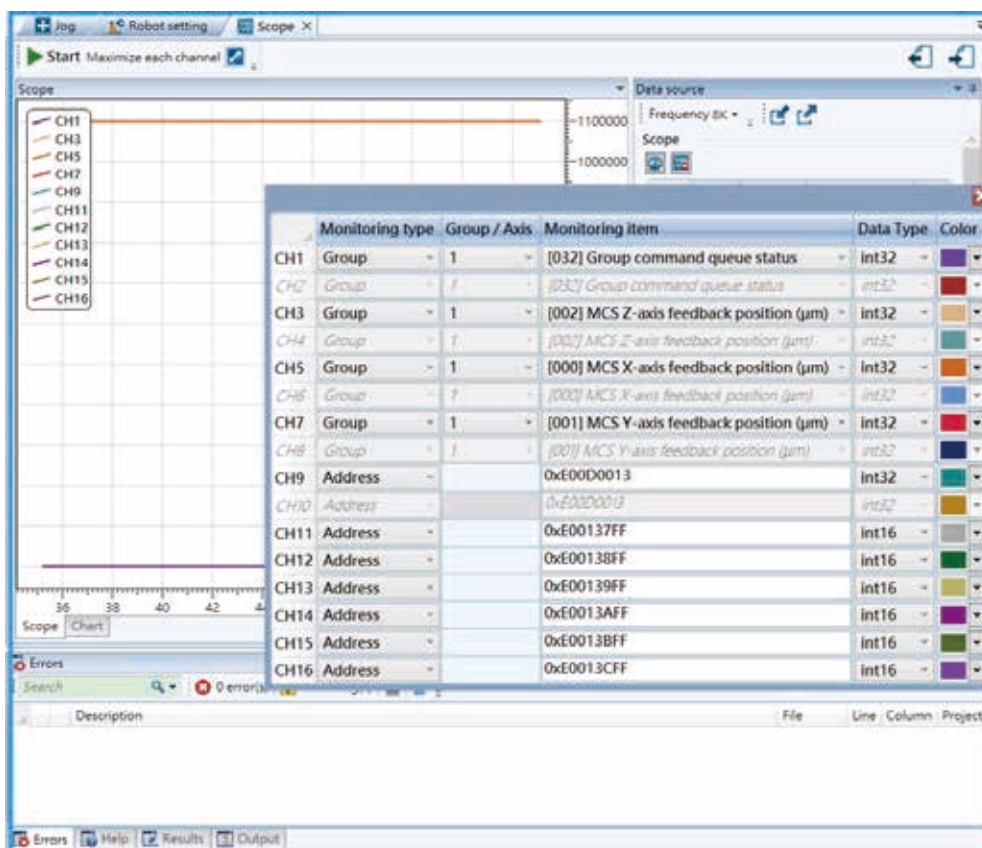

## Robot Teaching Function

Operates and instantly records different coordination types, including geodetic coordinates, user coordinates, and work coordinates for precise robot positioning

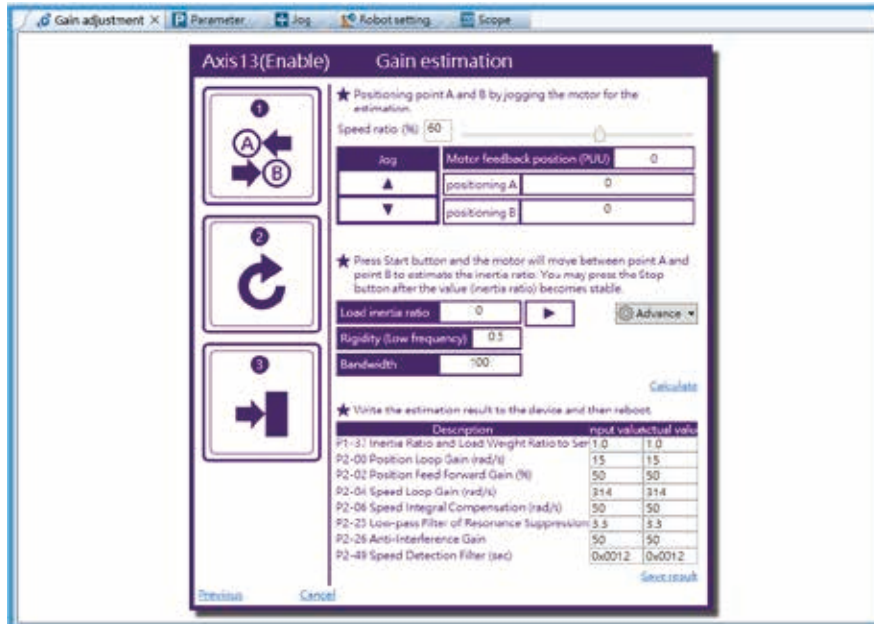

## Dynamic Tuning

Provides a convenient dynamic tuning function to adjust parameters of each axis for system optimization

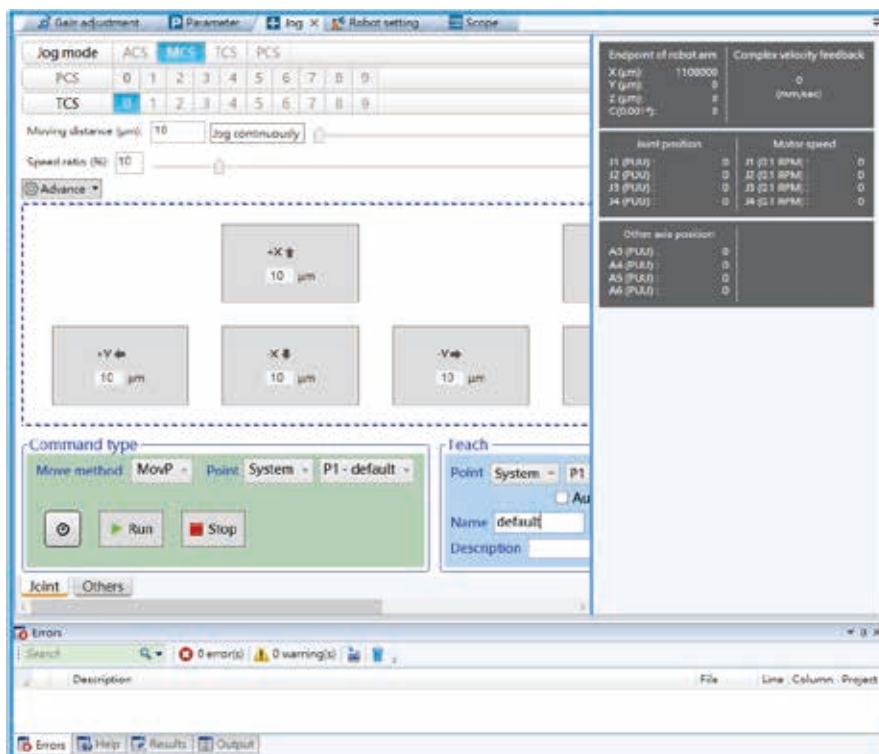

# Successful Applications

## Robotic Soldering Solutions

- Robot controller with servo drive integrated for space savings and simple wiring
- Uses soldering software to export PCB CAD files of solder holes for robot controller to control SCARA in achieving soldering with high speed
- Auto calibration for correcting deviation when changing soldering tools to achieve precision soldering
- Total solution adopts Delta industrial automation products for easy integration and maintenance

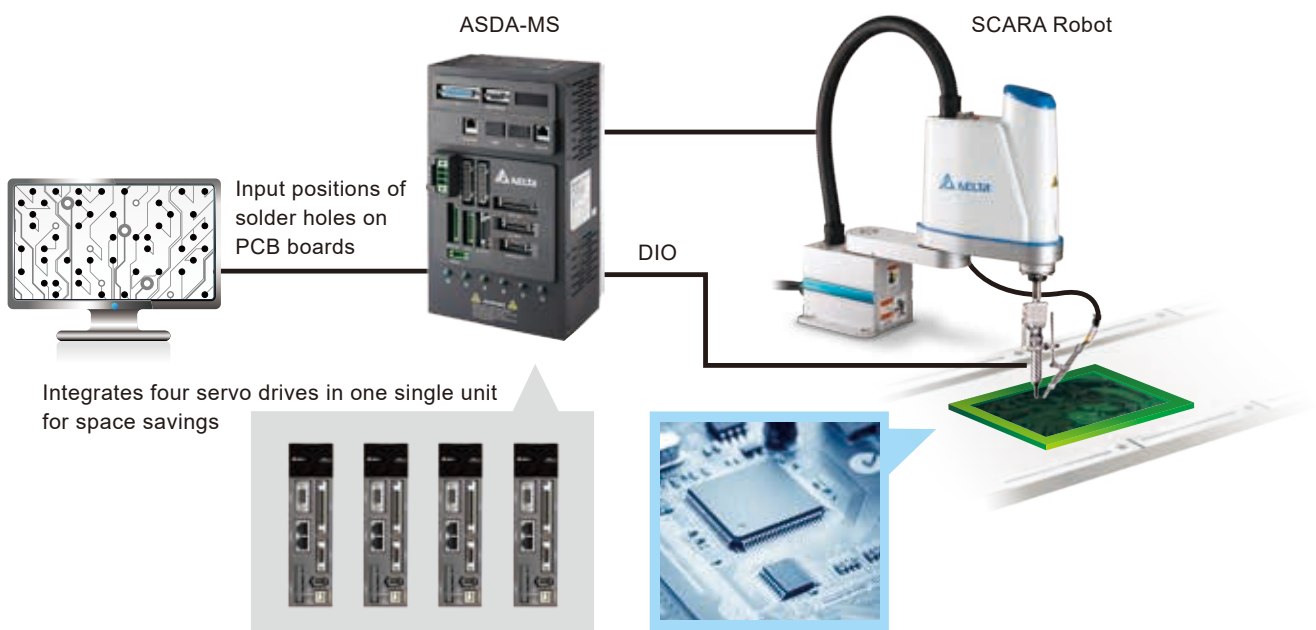

## Automatic Screw-Driving Solution

- Robot controller with servo drive integrated for space savings and easy wiring
- SCARA delivers consistent quality with high repeatability
- Flexible robot teaching movement and motion control for interchangeable production
- Total solution adopts Delta industrial automation products for easy integration and maintenance

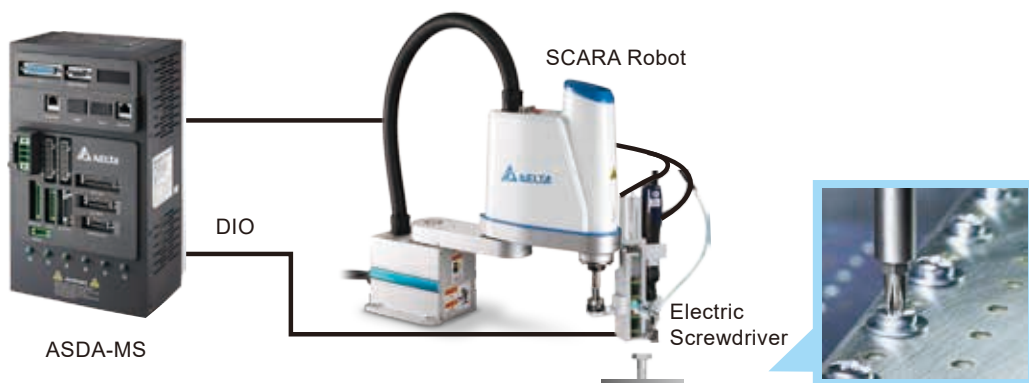

# Successful Applications

## Conveyor Tracking and Glue Dispensing Solution

- SCARA provides fixture-less conveyor tracking with precise glue dispensing
- Synchronizes robot movement to handle workpieces without stopping conveyor for enhanced production efficiency
- Customer-driven PC software offers flexible adjustment and assists users redesign and self-develop for customized applications
- General communication interface easily connects different machine vision systems and modules
- Simple system configuration to perform glue dispensing during conveyance
- Total solution adopts Delta industrial automation products for easy integration and maintenance

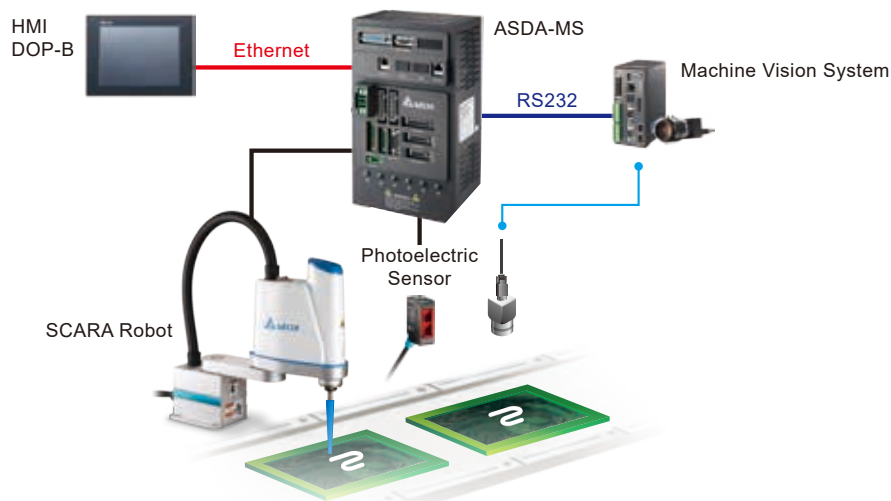

## Five-side Appearance Inspection of Finished Goods Solution

- Robot controller with servo drive integrated for saving space and easy wiring
- Combines flexible robot movement with machine vision system for quick inspection of multi-products production
- Simplified system with high reliability and simple wiring configuration via MODBUS communication structure
- Links to MES System for optimized manufacturing and interchangeable production
- Total solution adopts Delta industrial automation products for easy integration and maintenance

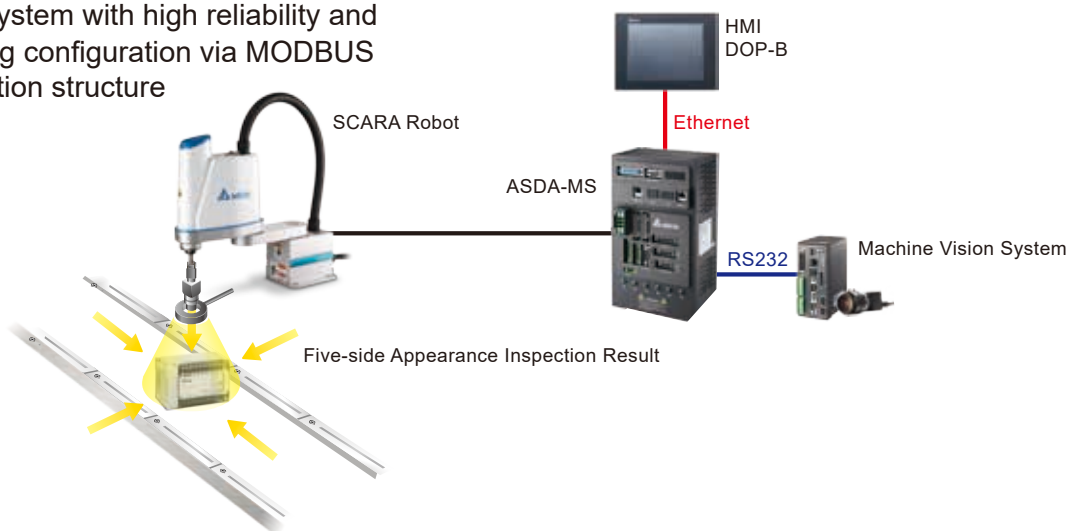

# Ordering Information

## ASDA-MS Series Controller

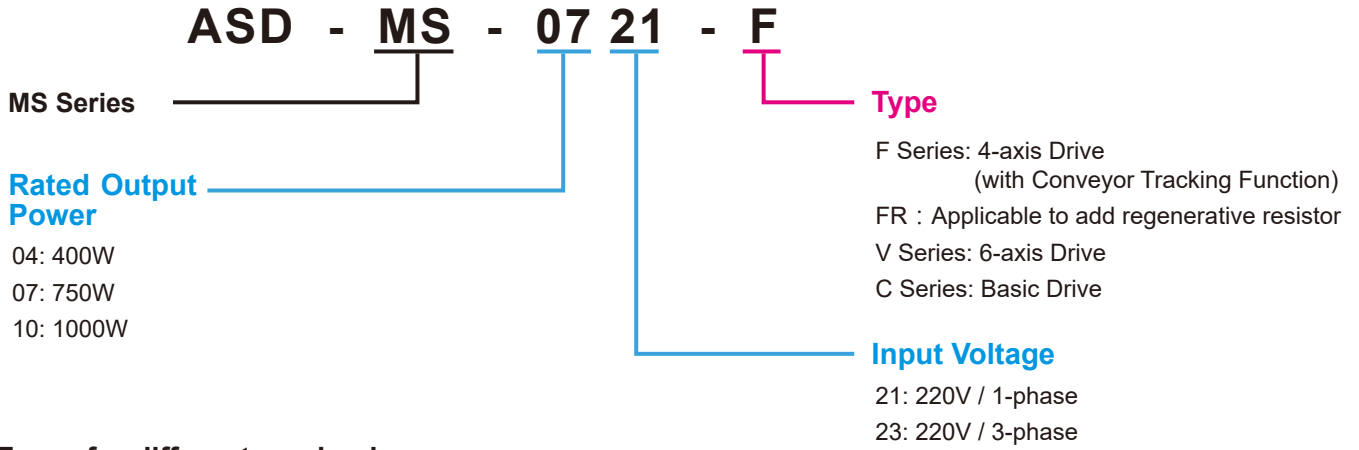

### Types for different mechanisms

	Right angle	SCARA	Articulated	DELTA	Press Unloader	Common Version*
F / FR	●	●		●	●	●
C	●	●			●	
V			●			●

\*Conveyor tracking function available

## ECMA Series Servo Motors\*1

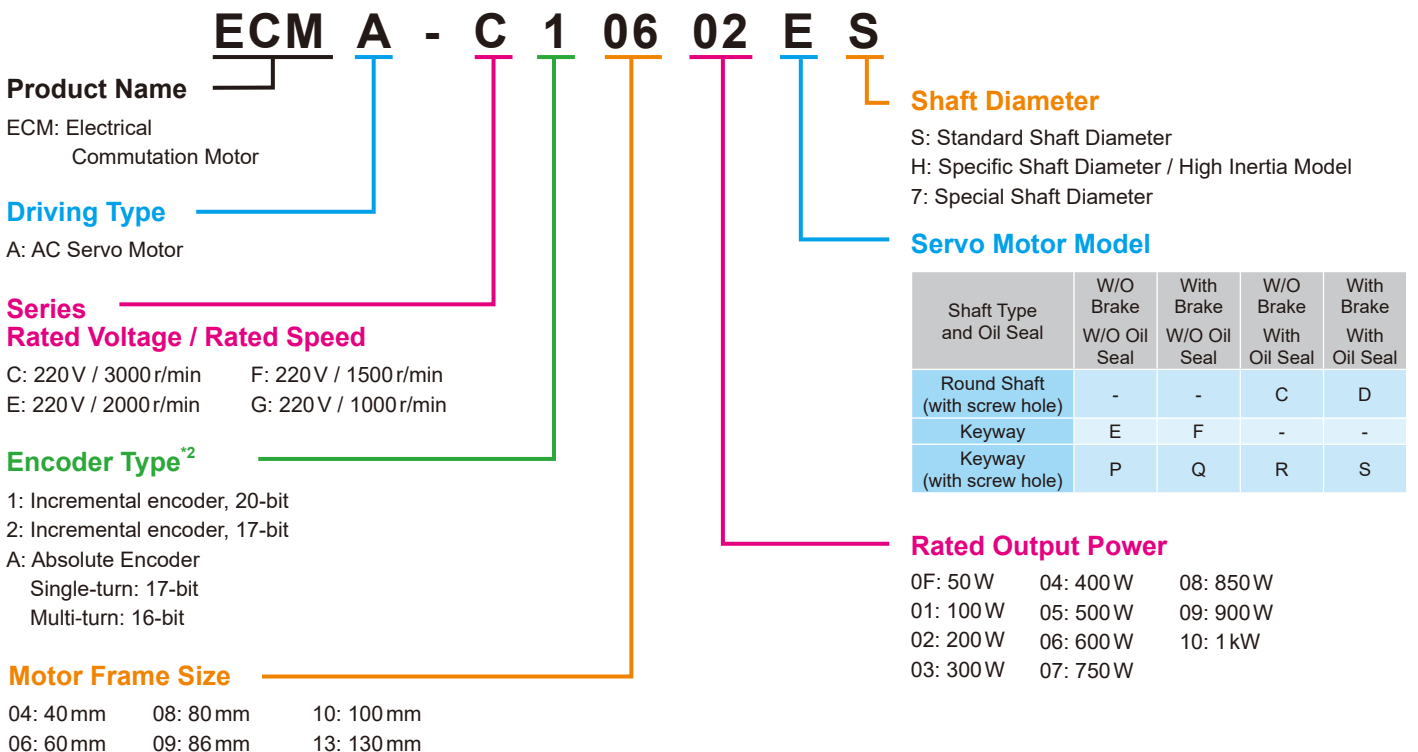

\*1: The external axes for ASDA-MS Series must support DMCNET Communication

\*2: The motor for ASDA-MS Series must align with the same encoder type

## ECMC Series Servo Motors

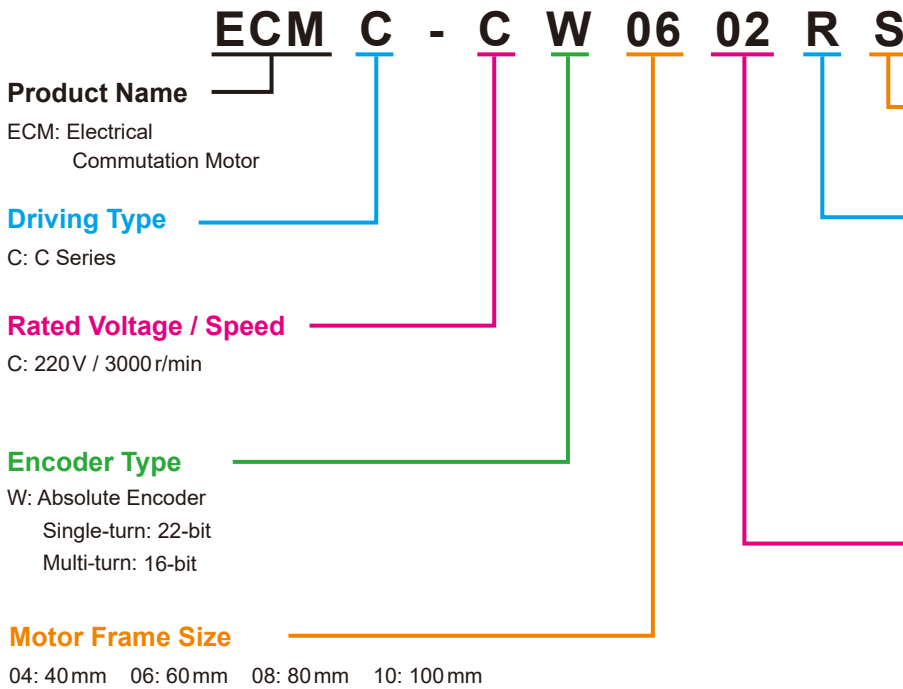

### Shaft Diameter

S: Standard Shaft Diameter

### Servo Motor Model

Shaft Type and Oil Seal	W/O Brake	With Brake	W/O Brake	W/O Brake
	W/O Oil Seal	W/O Oil Seal	With Oil Seal	With Oil Seal
Round Shaft (with screw hole)	-	-	-	-
Keyway	-	-	-	-
Keyway (with screw hole)	-	-	R	S

### Rated Output Power

01: 100W 07: 750W  
02: 200W 10: 1KW  
04: 400W

## ECMR Series Servo Motor

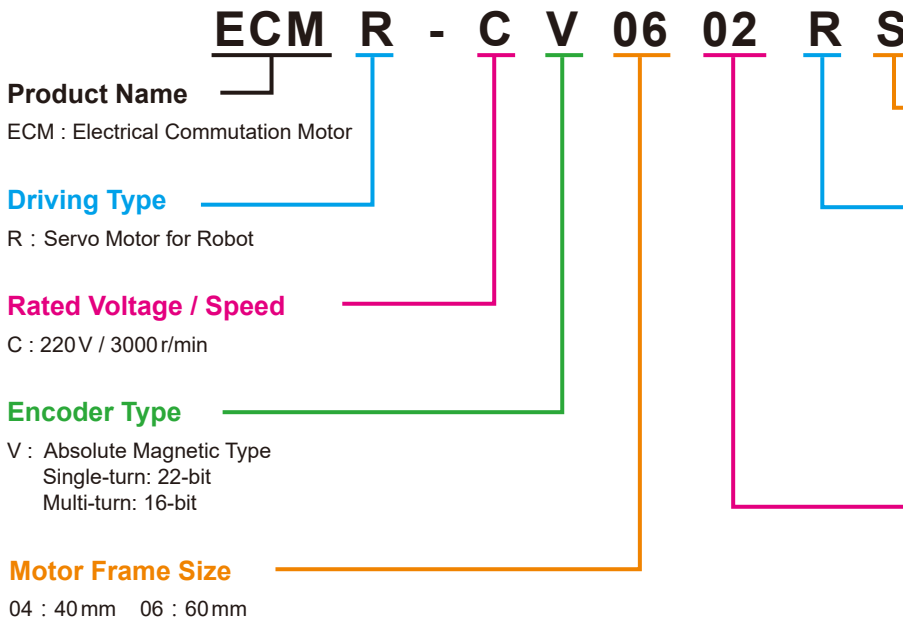

### Shaft Diameter

S: Standard Shaft Diameter

### Servo Motor Model

Shaft Type and Oil Seal	W/O Brake	With Brake	W/O Brake	W/O Brake
	W/O Oil Seal	W/O Oil Seal	With Oil Seal	With Oil Seal
Round Shaft (with screw hole)	-	-	-	-
Keyway	-	-	-	-
Keyway (with screw hole)	-	-	R	S

### Rated Output Power

01 : 100W  
02 : 200W  
04 : 400W



## ECMC-A3 Series Servo Motors

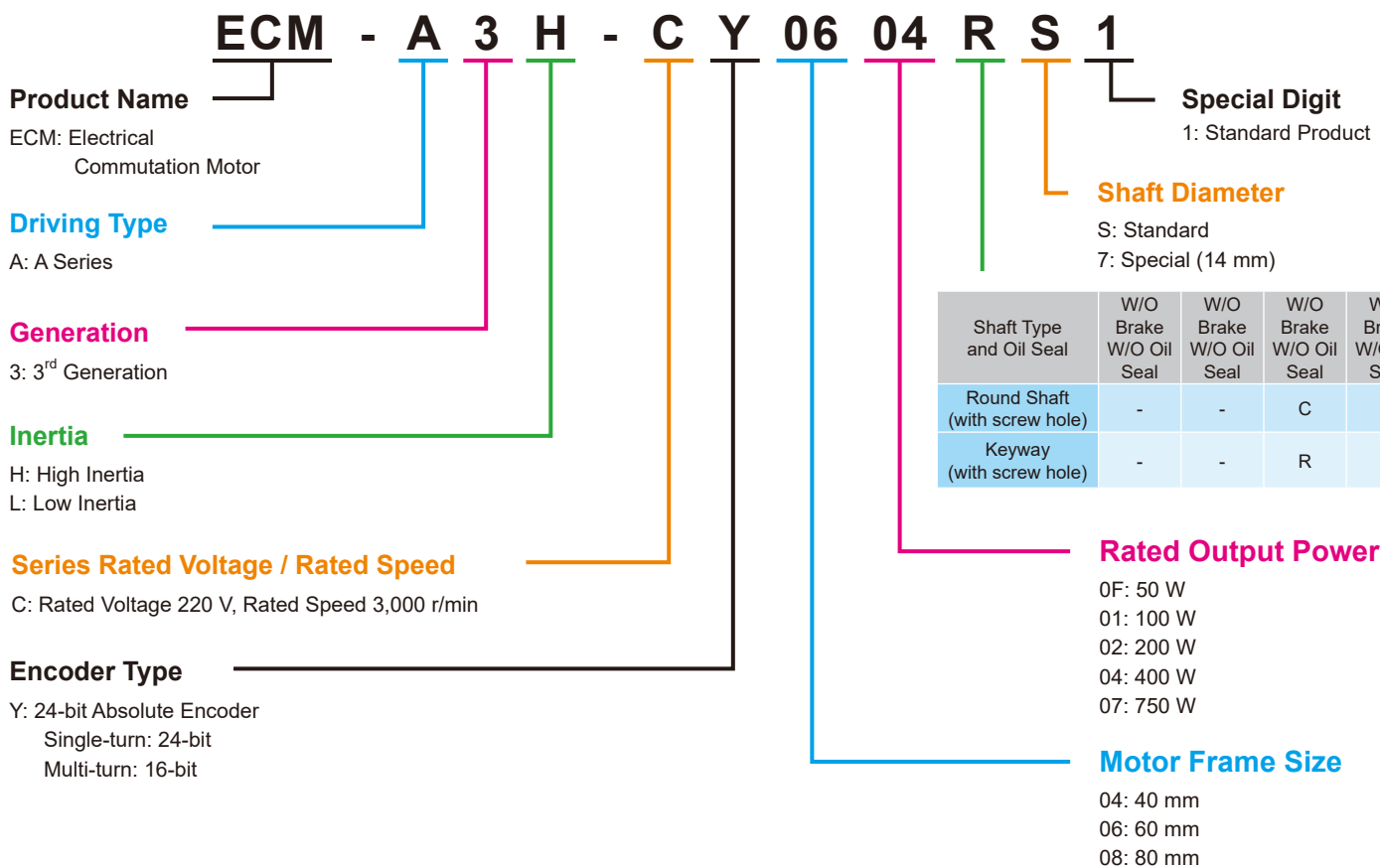

# Servo Motor Specifications

Model Name	Rated output power (kW)	Rated voltage	Frame	Rated speed	Servo Motor Model Name	Shaft Diameter	Notes
ASD-MS-0421-F-□	100	220V	40	3000RPM	ECMA-C △ 0401 □ S	8mm	
	100	220V	40	3000RPM	ECMC-CW0401 □ S	8mm	Absolute Magnetic Encoder (Single-turn: 22 bit / Multi-turn: 16 bit)
	100	220V	40	3000RPM	ECM-A3 ○ - △ 0401 □ S	8mm	
	100	220V	40	3000RPM	ECMR-CV0401RS	8mm	Absolute Magnetic Encoder (Single-turn: 22 bit / Multi-turn: 16 bit)
	200	220V	60	3000RPM	ECMA-C △ 0602 □ S	14mm	
	200	220V	60	3000RPM	ECMC-CW0602 □ S	14mm	Absolute Magnetic Encoder (Single-turn: 22 bit / Multi-turn: 16 bit)
	200	220V	60	3000RPM	ECM-A3 ○ - △ 0602 □ S	14mm	
	200	220V	60	3000RPM	ECMR-CV0602RS	14mm	Absolute Magnetic Encoder (Single-turn: 22 bit / Multi-turn: 16 bit)
	400	220V	60	3000RPM	ECMA-C △ 0604 □ S	14mm	
	400	220V	60	3000RPM	ECMC-CW0604 □ S	14mm	Absolute Magnetic Encoder (Single-turn: 22 bit / Multi-turn: 16 bit)
	400	220V	60	3000RPM	ECMA-C △ 0604 □ H	14mm	High Inertia
	400	220V	60	3000RPM	ECM-A3 ○ - C △ 0604 □ S	14mm	
	400	220V	60	3000RPM	ECMR-CV0604RS	14mm	Absolute Magnetic Encoder (Single-turn: 22 bit / Multi-turn: 16 bit)
	400	220V	80	3000RPM	ECMA-C △ 0804 □ 7	14mm	
	400	220V	80	3000RPM	ECM-A3H-C △ 0804 □ S	14mm	
ASD-MS-0721-□	750	220V	80	3000RPM	ECMA-C △ 0807 □ S	19mm	
	750	220V	80	3000RPM	ECMC-CW0807 □ S	19mm	Absolute Magnetic Encoder (Single-turn: 22 bit / Multi-turn: 16 bit)
	750	220V	80	3000RPM	ECMA-C △ 0807 □ H	19mm	High Inertia
	750	220V	80	3000RPM	ECM-A3 ○ - △ 0807 □ S	19mm	
	750	220V	86	3000RPM	ECMA-C △ 0907 □ S	16mm	
ASD-MS-1023-□	1000	220V	80	3000RPM	ECMA-C △ 0810 □ S	19mm	
	1000	220V	86	3000RPM	ECMA-C △ 0910 □ S	16mm	
	1000	220V	100	3000RPM	ECMA-C △ 1010 □ S	22mm	
	1000	220V	130	2000RPM	ECMA-E △ 1310 □ S	22mm	
	1000	220V	130	2000RPM	ECMA-E △ 1315 □ S	22mm	
	1000	220V	130	2000RPM	ECMA-E △ 1815 □ S	35mm	

\*1. △ =1: Incremental encoder, 20-bit ; △ =2: Incremental encoder, 17-bit ; △ =A: Absolute encoder (Single-turn 17bit/ Multi-turn 16bit)

\*2. □ = shaft end/brake or the number of oil seals

\*3. ○ =L: Low Inertia ; ○ =H: High Inertia

# Servo Drive and Servo Motor Combinations

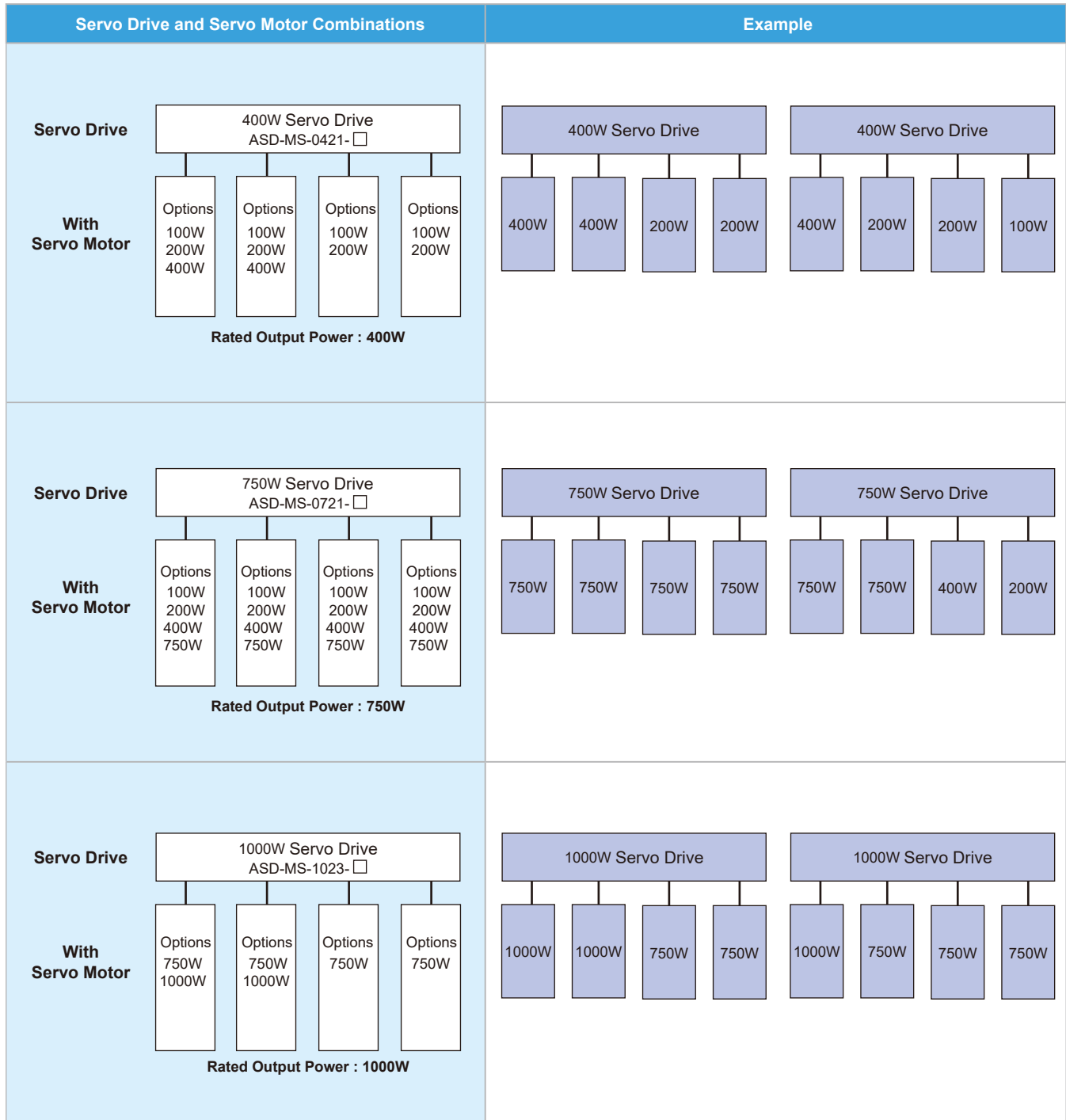

# Specifications

ASDA-MS Series		400W (for 4 axes of control)		750W (for 4 axes of control)		1000W (for 4 axes of control)	
		04		07		10	
Power Supply	Phase / Voltage	Three-phase / Single-phase 220 V <sub>AC</sub>		Three-phase / Single-phase 220 V <sub>AC</sub>		3-phase 220 V <sub>AC</sub>	
	Permissible Voltage Range	Three-phase / Single-phase: 200 ~ 230 V <sub>AC</sub> · -15% ~ 10%		Three-phase / Single-phase: 200 ~ 230 V <sub>AC</sub> · -15% ~ 10%		3-phase: 200 ~ 230 V <sub>AC</sub> · -15% ~ 10%	
	Control of Main Circuit	24V <sub>DC</sub> · -10%~10%					
	Input Current (3PH) (Units: Arms)	8.1		12.4		16.4	
	Input Current (1PH) (Units: Arms)	14.8		23.8		-	
	Continuous Output Current (Units: Arms)	2.6		5.1 (for each axis)		7.3(J1.J2) / 5.1(J3.J4)	
Dimensions (W) x (H) x (D) mm / Weight		175 mm x 300 mm x 159 mm / 5.6 kg					
Cooling System		Fan Cooling					
Encoder Resolution / Feedback Resolution		20-bit (1280000 p/rev)					
Control of Main Circuit		SVPWM (Space Vector Pulse Width Modulation) Control					
Tuning Modes		Auto / Manual					
Regenerative Resistor		Built-in					
Robot Control	Programming Languages	Supports IEC61131-3 PLC, Delta Robot Language (DRL), NC-code (basic language)					
	Motion Control Mode	PTP (Point to Point) Motion, Linear Interpolation, Circular interpolation					
	Memory Capacity	20MByte for User Program and Data Memory 16KByte for PLC SV/DV Variables (Not Retained) 60KByte for PLC DH Variables (Retained)		1K Points for Global Use (shareable in different programs) Max. 32K Points for Every User Program			
Input / Output	Digital I/O	Standard I/O: Input: 24; Output: 12 System I/: Input: 8; Output: 8					
	Brake Output	Output: 4					
Communication Interfaces	Ethernet	1 Channel					
	RS-232 / RS-485	1 Port (One port can switch two communication function)					
	DMCNET	1 Channel					
	USB Host	1 Port					
Environment	Installation Site	Indoor location (free from direct sunlight) No corrosive liquid and gas (far away from oil mist, flammable gas, dust)					
	Altitude	Altitude 1000m or lower above sea level					
	Atmospheric Pressure	86 kPa ~ 106 kPa					
	Operating Temperature <sup>2</sup>	Combination of Motors	Max. Operating Temperature Limit	Combination of Motors	Max. Operating Temperature Limit	Combination of Motors	Max. Operating Temperature Limit
		-	-	750 W × 4	40°C	-	-
		400 W × 2 200 W × 2	55°C	750 W × 2 400 W × 2	45°C	1000 W × 2 750 W × 2	40°C
		200 W × 4	55°C	400 W × 4	50°C	750 W × 4	40°C
		200 W × 2 100 W × 2	55°C	400 W × 2 200 W × 2	55°C	750 W × 2 400 W × 2	45°C
	Storage Temperature	-20°C ~ 65°C					
	Humidity	0 ~ 90% RH (non-condensing)					
	Vibration	9.80665 m/s <sup>2</sup> (1G) less than 20 Hz, 5.88 m/s <sup>2</sup> (0.6G) 20 ~ 50 Hz					
IP Rating	IP20						
Power System	TN System <sup>1</sup>						
Certifications	IEC/EN 61800-5-1, UL 508C, RCM 						

\*1. TN system: A power distribution system having one point directly earthed, the exposed conductive parts of the installation being connected to that point by a protective earth conductor  
\*2. Operating temperature: please apply this robot controller based on the power output and under appropriate temperature, and avoid extreme heat for normal operation

# Exterior of the Robot Controller

## Teaching Pendant Connection Port

## High-speed Communication Port

- Ethernet: ModbusTCP communication protocol
- USB1, USB2: for USB flash drives
- DMCNET: for DMCNET peripherals

## Main Circuit Terminal (R, S, T)

Supports 200 ~ 230V<sub>AC</sub>, 50/60Hz commercial power supply

## Motor Brake Output Terminal (BRK. DIO)

## STO I/O Terminal (Safe Torque Off)

Used to connect a certified safety relay or switch for controlling STO I/O signals

## Control Circuit Terminal

Connects DC24V power supply

## System I/O Terminal (SYS. DIO)

## Serial Communication Port

For MODBUS communication control, supporting RS-485 / RS-232 serial communication

## LED Display

Indicates the controller's status or fault codes (5 digit, 7 segment)

## Servo Motor Output (U, V, W)

Connects the servo motors (please do not connect main circuit power to the terminal as the controller may be damaged)

## Standard I/O Terminal (STD. DIO)

## Full-Closed Loop Control Interface (EXT. ENC)

Supports position feedback signals (A, B, Z phase)

## Motor Encoder Interface (MOTOR. ENC.)

Connects the encoder signals of 4 servo motors

## Ground Terminal

Connects the grounding wire of power supply and servo motor



# Dimensions of the Robot Controller

Unit: mm (inch) Weight: 5.6 kg

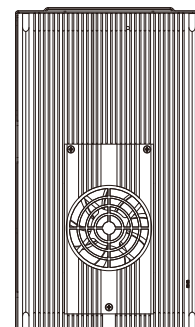
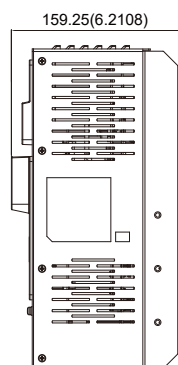
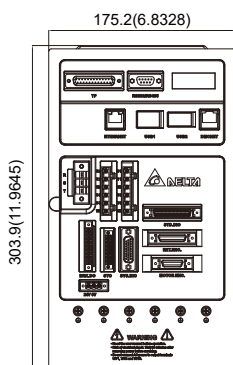

Screw: M4\*0.7  
Torque: 14 kgf-cm

### NOTE

- 1) Dimensions are in millimeters (inches); Weights are in kilograms (kg) and (pounds (lbs))
- 2) Dimensions and weights of the robot controller may be revised without prior notice

# Dimensions of Servo Motors

- ECM-A3 Series

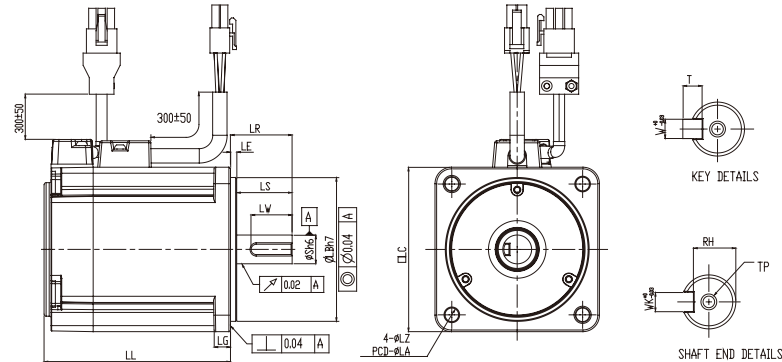

Model	C □ 0401 □ 2 S □	C □ 0602 □ 2 S □	C □ 0604 □ 2 S □	C □ 0804 □ 2 7 □	C □ 0807 □ 2 S □
LC	40	60	60	80	80
LZ	4.5	5.5	5.5	6.6	6.6
LA	46	70	70	90	90
S	8 ( $+0$ / $-0.009$ )	14 ( $+0$ / $-0.011$ )	14 ( $+0$ / $-0.011$ )	14 ( $+0$ / $-0.011$ )	19 ( $+0$ / $-0.013$ )
LB	30 ( $+0$ / $-0.021$ )	50 ( $+0$ / $-0.025$ )	50 ( $+0$ / $-0.025$ )	70 ( $+0$ / $-0.03$ )	70 ( $+0$ / $-0.03$ )
LL (Without Brake)	85.3	84	106	93.7	115.8
LL (With Brake)	120.1	117.6	139.7	131.2	153.2
LS	22.5	27	27	27	37
LR	25	30	30	30	40
LE	2.5	3	3	3	3
LG	5	7.5	7.5	8	8
LW	16	20	20	20	25
RH	6.2	11	11	11	15.5
WK	3	5	5	5	6
W	3	5	5	5	6
T	3	5	5	5	6
TP	M3 Depth 8	M4 Depth 15	M4 Depth 15	M4 Depth 15	M6 Depth 20



**NOTE**

- Unit: mm
- In servo motor model names, □ signifies encoder type, □ signifies shaft diameter and oil seal, and □ signifies special code

## Speed-Torque Curves (T-N Curves)

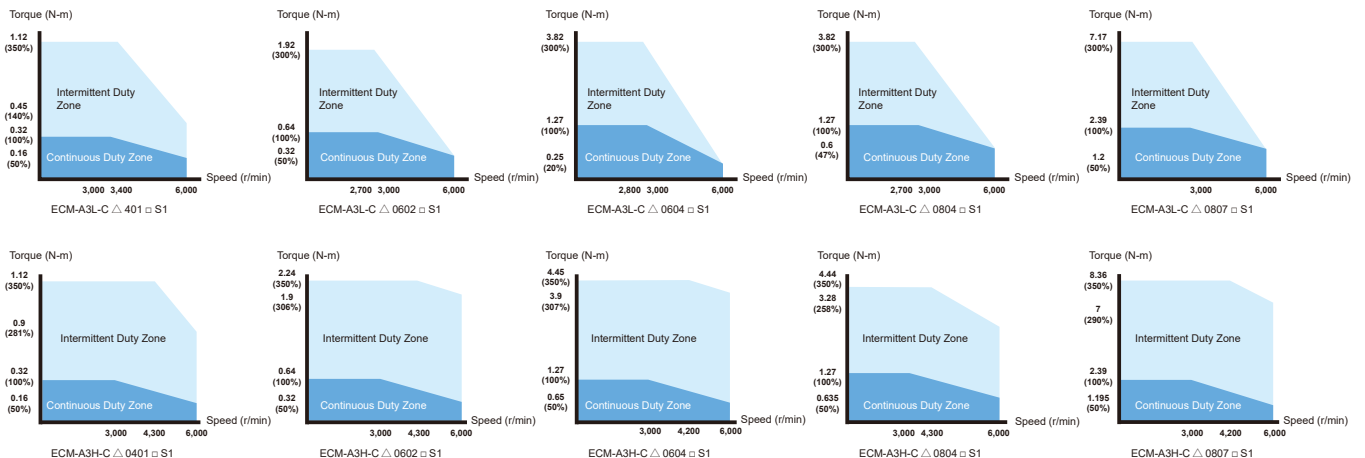

# Servo Motor Dimensions

- ECMA Frame Number 86 Series (including the following models)

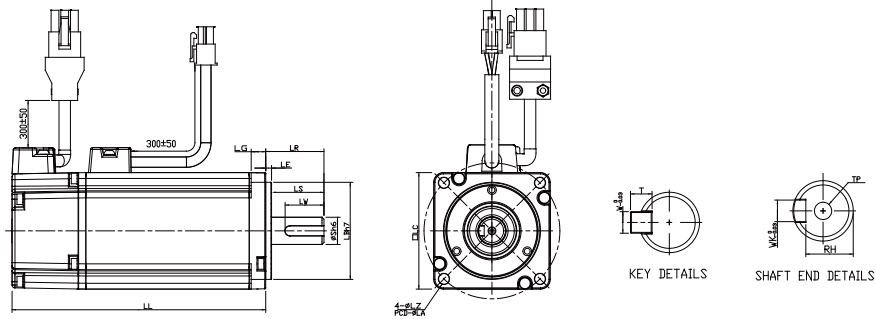

Model	C1040F □ S	C △ 0401 □ S	C △ 0602 □ S	C △ 0604 □ S	C △ 0604 □ H	C △ 0804 □ 7	C △ 0807 □ S	C △ 0807 □ H	C △ 0907 □ S	C △ 0910 □ S
LC	40	40	60	60	60	80	80	80	86	86
LZ	4.5	4.5	5.5	5.5	5.5	6.6	6.6	6.6	6.6	6.6
LA	46	46	70	70	70	90	90	90	100	100
S	8( $+0$ -0.009 )	8( $+0$ -0.009 )	14( $+0$ -0.011 )	14( $+0$ -0.011 )	14( $+0$ -0.011 )	14( $+0$ -0.011 )	19( $+0$ -0.013 )	19( $+0$ -0.013 )	16( $+0$ -0.011 )	16( $+0$ -0.011 )
LB	30( $+0$ -0.021 )	30( $+0$ -0.021 )	50( $+0$ -0.025 )	50( $+0$ -0.025 )	50( $+0$ -0.025 )	70( $+0$ -0.030 )	70( $+0$ -0.030 )	70( $+0$ -0.030 )	80( $+0$ -0.030 )	80( $+0$ -0.030 )
LL (without brake)	79.1	100.6	105.5	130.7	145.8	112.3	138.3	151.1	130.2	153.2
LL ( with brake )	--	136.8	141.6	166.8	176.37	152.8	178	189	161.3	184.3
LS	20	20	27	27	27	27	32	32	30	30
LR	25	25	30	30	30	30	35	35	35	35
LE	2.5	2.5	3	3	3	3	3	3	3	3
LG	5	5	7.5	7.5	7.5	8	8	8	8	8
LW	16	16	20	20	20	20	25	25	20	20
RH	6.2	6.2	11	11	11	11	15.5	15.5	13	13
WK	3	3	5	5	5	5	6	6	5	5
W	3	3	5	5	5	5	6	6	5	5
T	3	3	5	5	5	5	6	6	5	5
TP	M3 Depth 8	M3 Depth 8	M4 Depth 15	M4 Depth 15	M4 Depth 15	M4 Depth 15	M6 Depth 20	M6 Depth 20	M5 Depth 15	M5 Depth 15

- NOTE**
- 1) Dimensions: millimeters (mm)
  - 2) Dimensions of the servo motors may be revised without prior notice
  - 3) The boxes (□) in the model names are for optional configurations (keyway, brake and oil seal)
  - 4) The boxes (△) in the model names are for resolution types  
(△=1: Incremental encoder, 20-bit; △=2: Incremental encoder, 17-bit)

## Speed-Torque Curves (T-N Curves)

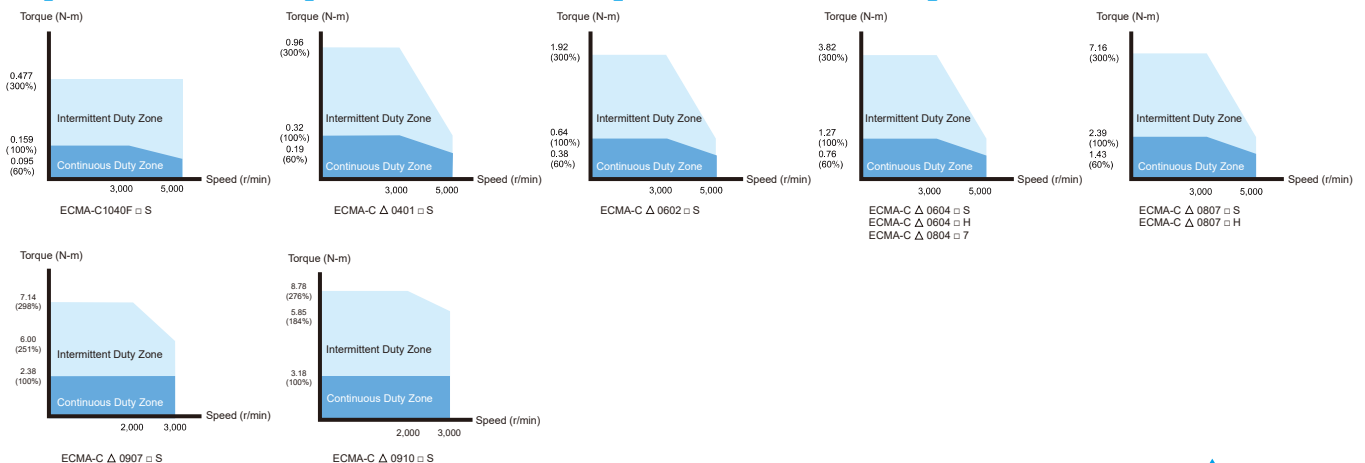

# Servo Motor Dimensions

- ECMA Frame Number 100 / 130 Series

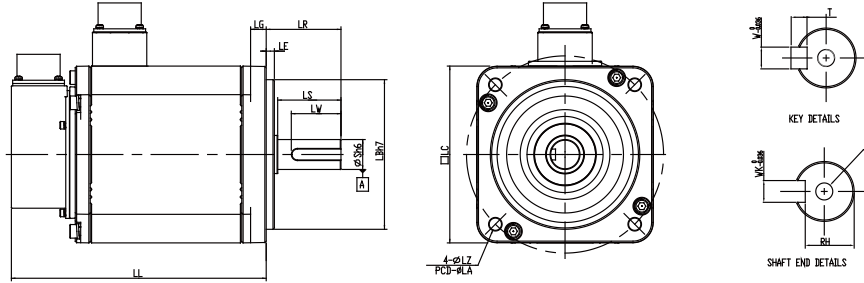

Model	C $\triangle$ 1010 $\square$ S	E $\triangle$ 1305 $\square$ S	E $\triangle$ 1310 $\square$ S	E $\triangle$ 1315 $\square$ S	F $\triangle$ 1308 $\square$ S	G $\triangle$ 1303 $\square$ S	G $\triangle$ 1306 $\square$ S	G $\triangle$ 1309 $\square$ S
LC	100	130	130	130	130	130	130	130
LZ	9	9	9	9	9	9	9	9
LA	115	145	145	145	145	145	145	145
S	22 <sup>(+0)</sup> <sub>(-0.013)</sub>	22 <sup>(+0)</sup> <sub>(-0.013)</sub>	22 <sup>(+0)</sup> <sub>(-0.013)</sub>	22 <sup>(+0)</sup> <sub>(-0.013)</sub>	22 <sup>(+0)</sup> <sub>(-0.013)</sub>	22 <sup>(+0)</sup> <sub>(-0.013)</sub>	22 <sup>(+0)</sup> <sub>(-0.013)</sub>	22 <sup>(+0)</sup> <sub>(-0.013)</sub>
LB	95 <sup>(+0)</sup> <sub>(-0.035)</sub>	110 <sup>(+0)</sup> <sub>(-0.035)</sub>	110 <sup>(+0)</sup> <sub>(-0.035)</sub>	110 <sup>(+0)</sup> <sub>(-0.035)</sub>	110 <sup>(+0)</sup> <sub>(-0.035)</sub>	110 <sup>(+0)</sup> <sub>(-0.035)</sub>	110 <sup>(+0)</sup> <sub>(-0.035)</sub>	110 <sup>(+0)</sup> <sub>(-0.035)</sub>
LL (without brake)	153.3	147.5	147.5	167.5	152.5	147.5	147.5	163.5
LL (with brake)	192.5	183.5	183.5	202	181	183.5	183.5	198
LS	37	47	47	47	47	47	47	47
LR	45	55	55	55	55	55	55	55
LE	5	6	6	6	6	6	6	6
LG	12	11.5	11.5	11.5	11.5	11.5	11.5	11.5
LW	32	36	36	36	36	36	36	36
RH	18	18	18	18	18	18	18	18
WK	8	8	8	8	8	8	8	8
W	8	8	8	8	8	8	8	8
T	7	7	7	7	7	7	7	7
TP	M6 Depth 20	M6 Depth 20	M6 Depth 20	M6 Depth 20	M6 Depth 20	M6 Depth 20	M6 Depth 20	M6 Depth 20

- NOTE**
- 1) Dimensions: millimeters (mm)
  - 2) Dimensions of the servo motors may be revised without prior notice
  - 3) The boxes ( $\square$ ) in the model names are for optional configurations (keyway, brake and oil seal)
  - 4) The boxes ( $\triangle$ ) in the model names are for resolution types.  $\triangle$  =1: Incremental encoder, 20-bit;  $\triangle$  =2: Incremental encoder, 17-bit;  $\triangle$  =A: Absolute type

# Speed-Torque Curves (T-N Curves)

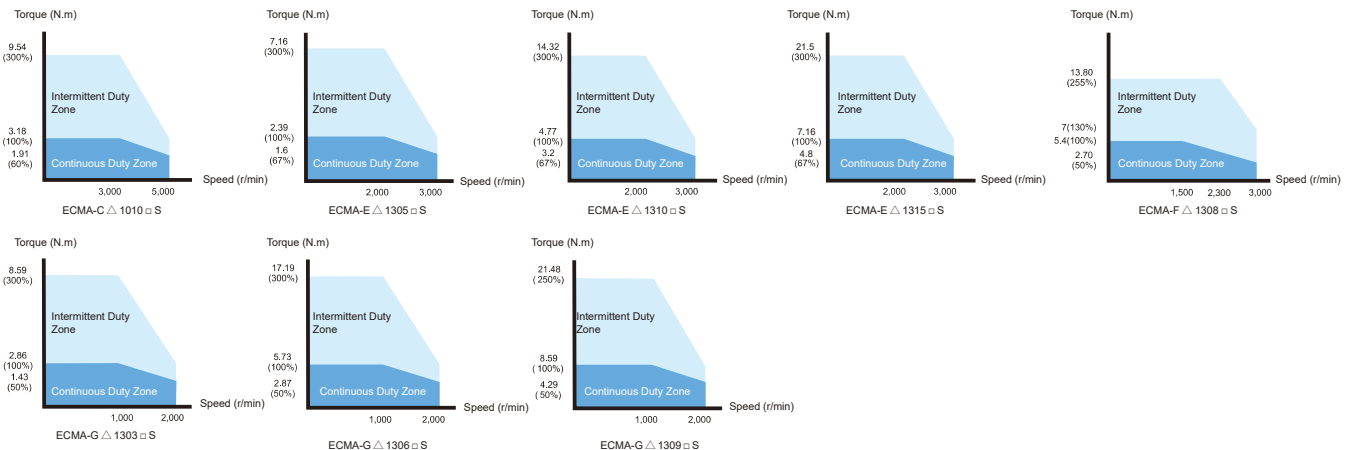



# Servo Motor Specifications

- ECM-A3L/A3H Series

ECM-A3 Series	ECM-A3L					ECM-A3H				
	C △ 04	C △ 06	C △ 06	C △ 08	C △ 08	C △ 04	C △ 06	C △ 06	C △ 08	C △ 08
	01	02	04	04	07	01	02	04	04	07
Rated output power (kW)	0.1	0.2	0.4	0.4	0.75	0.1	0.2	0.4	0.4	0.75
Rated torque (N-m) <sup>*1</sup>	0.32	0.64	1.27	1.27	2.39	0.32	0.64	1.27	1.27	2.39
Maximum torque (N-m)	1.12	1.92	3.82	3.82	7.17	1.12	2.24	4.45	4.44	8.36
Rated speed (r/min)	3000									
Maximum speed (r/min)	6000									
Rated current (A)	0.89	1.45	2.65	2.6	5.1	0.9	1.45	2.65	2.6	4.5
Maximum current (A)	3.5	5	8.5	8.6	15.9	3.52	5.4	9.9	9.4	16.6
Power rating (kW/s)	25.3	45.5	107.5	45.4	111	13.8	16.4	35.8	17.5	37.8
Rotor moment of inertia (x10 <sup>-4</sup> kg-m <sup>2</sup> )(without brake)	0.0405	0.09	0.15	0.355	0.513	0.0742	0.25	0.45	0.92	1.51
Mechanical time constant (ms)	0.817	0.64	0.41	0.68	0.405	1.38	1.37	0.96	1.31	0.91
Torque constant-KT (N-m/A)	0.36	0.44	0.48	0.49	0.469	0.356	0.44	0.48	0.49	0.53
Voltage constant-KE (mV/(r/min))	13.6	16.4	18	17.9	17	13.2	16.4	17.2	17.9	18.7
Armature resistance (Ohm)	9.47	4.9	2.27	1.6	0.6	8.34	3.18	1.68	1.19	0.57
Armature inductance (mH)	16.2	18.52	10.27	10.6	4.6	11	8.15	4.03	4.2	2.2
Electrical time constant (ms)	1.71	3.78	4.52	6.63	7.67	1.32	2.14	2.4	3.53	3.86
Insulation class	A class (UL), B class (CE)									
Insulation resistance	100MΩ, DC 500V above									
Insulation strength	1.8k V <sub>AC</sub> , 1 sec									
Weight (kg)(without brake)	0.5	1.1	1.4	2.05	2.8	0.5	1.1	1.4	2.05	2.8
Weight (kg)(with brake)	0.8	1.6	1.9	2.85	3.6	0.8	1.6	1.9	2.85	3.6
Max. radial shaft load (N)	78	245	245	392	392	78	245	245	392	392
Max. thrust shaft load (N)	54	74	74	147	147	54	74	74	147	147
Power rating (kW/s)(with brake)	24.5	37.24	89.6	41	95.4	13.6	15.17	34.32	15.1	34.4
Rotor moment of inertia (x10 <sup>-4</sup> kg-m <sup>2</sup> )(with brake)	0.0418	0.12	0.18	0.393	0.599	0.0755	0.28	0.48	1.07	1.66
Mechanical time constant (ms)(with brake)	0.844	0.88	0.47	0.75	0.472	1.4	1.52	1.01	1.53	1
Brake holding torque [N-t (min)] <sup>2</sup>	0.32	1.3	1.3	2.5	2.5	0.32	1.3	1.3	2.5	2.5
Brake power consumption (at 20°C) [W]	7.3	7.2	7.2	8.4	8.4	7.3	7.2	7.2	8.4	8.4
Brake release time [ms (Max)]	5	20	20	20	20	5	20	20	20	20
Brake pull-in time [ms (Max)]	25	50	50	70	70	25	50	50	70	70
Vibration grade (μm)	16					15				
Operating temperature (°C)	0°C ~ 40°C									
Storage temperature (°C)	-10°C ~ 80°C									
Operating humidity	20 ~ 90%RH (non-condensing)									
Storage humidity	20 ~ 90%RH (non-condensing)									
Vibration capacity	2.5G									
IP Rating	IP65 (when waterproof connectors are used, or when an oil seal is used to be fit to the rotating shaft)									
Approvals										

\*1 Rate torque values are continuous permissible values at 0 ~ 40°C ambient temperature when attaching with the sizes of heatsinks listed below:  
 ECMA-A3L\_\_ 04 / 06 / 08: 250 mm x 250 mm x 6 mm  
 Material: Aluminum – F60, F80

\*2 The holding brake is for holding the motor shaft, not for decelerating or stopping the machine

# Servo Motor Specifications

- Low Inertia Series

ECMA Series	C104	C △ 04	C △ 06		C △ 08		C △ 09		C △ 10
	0F	01	02	04 □ S	04	07	07	10	10
Rated output power (kW)	0.05	0.1	0.2	0.4	0.4	0.75	0.75	1.0	1.0
Rated torque (N-m) <sup>*1</sup>	0.159	0.32	0.64	1.27	1.27	2.39	2.39	3.18	3.18
Maximum torque (N-m)	0.477	0.96	1.92	3.82	3.82	7.16	7.14	8.78	9.54
Rated speed (r/min)	3000						3000		3000
Maximum speed (r/min)	5000						3000		5000
Rated current (A)	0.69	0.90	1.55	2.60	2.60	5.10	3.66	4.25	7.30
Maximum current (A)	2.05	2.70	4.65	7.80	7.80	15.3	11	12.37	21.9
Power rating (kW/s)	12.27	27.7	22.4	57.6	24.0	50.4	29.6	38.6	38.1
Rotor moment of inertia (x10 <sup>-4</sup> kg-m <sup>2</sup> )(without brake)	0.0206	0.037	0.177	0.277	0.68	1.13	1.93	2.62	2.65
Mechanical time constant (ms)	1.14	0.75	0.80	0.53	0.74	0.63	1.72	1.20	0.74
Torque constant-KT (N-m/A)	0.23	0.36	0.41	0.49	0.49	0.47	0.65	0.75	0.44
Voltage constant-KE (mV/(r/min))	9.8	13.6	16.0	17.4	18.5	17.2	24.2	27.5	16.8
Armature resistance (Ohm)	12.7	9.30	2.79	1.55	0.93	0.42	1.34	0.897	0.20
Armature inductance (mH)	26	24.0	12.07	6.71	7.39	3.53	7.55	5.7	1.81
Electrical time constant (ms)	2.05	2.58	4.30	4.30	7.96	8.36	5.66	6.35	9.30
Insulation class	A class (UL), B class (CE)								
Insulation resistance	100MΩ, DC 500V above								
Insulation strength	1.8k V <sub>AC</sub> , 1 sec								
Weight (kg)(without brake)	0.42	0.5	1.2	1.6	2.1	3.0	2.9	3.8	4.3
Weight (kg)(with brake)	--	0.8	1.5	2.0	2.9	3.8	3.69	5.5	4.7
Max. radial shaft load (N)	78.4	78.4	196	196	245	245	245	245	490
Max. thrust shaft load (N)	39.2	39.2	68	68	98	98	98	98	98
Power rating (kW/s)(with brake)	--	25.6	21.3	53.8	22.1	48.4	29.3	37.9	30.4
Rotor moment of inertia (x10 <sup>-4</sup> kg-m <sup>2</sup> )(with brake)	--	0.04	0.19	0.30	0.73	1.18	1.95	2.67	3.33
Mechanical time constant (ms)(with brake)	--	0.81	0.85	0.57	0.78	0.65	1.74	1.22	0.93
Brake holding torque [Nt-m (min)] <sup>2</sup>	--	0.3	1.3	1.3	2.5	2.5	2.5	2.5	8.0
Brake power consumption (at 20°C)[W]	--	7.3	6.5	6.5	8.2	8.2	8.2	8.2	18.7
Brake release time [ms (Max)]	--	5	10	10	10	10	10	10	10
Brake pull-in time [ms (Max)]	--	25	70	70	70	70	70	70	70
Vibration grade (μm)	15								
Operating temperature (°C)	0°C ~ 40°C								
Storage temperature (°C)	-10°C ~ 80°C								
Operating humidity	20 ~ 90%RH (non-condensing)								
Storage humidity	20 ~ 90%RH (non-condensing)								
Vibration capacity	2.5G								
IP Rating	IP65 (when waterproof connectors are used, or when an oil seal is used to be fit to the rotating shaft)								
Approvals									

\*1 Rate torque values are continuous permissible values at 0 ~ 40°C ambient temperature when attaching with the sizes of heatsinks listed below:

ECMA-\_\_ 04 / 06 / 08: 250 mm x 250 mm x 6 mm

ECMA-\_\_ 10: 300 mm x 300 mm x 12 mm

ECMA-\_\_ 13: 400 mm x 400 mm x 20 mm

Material: Aluminum – F40, F60, F80, F100, F130

\*2 The holding brake is for holding the motor shaft, not for decelerating or stopping the machine

# Servo Motor Specifications

- Medium / Medium-High / High Inertia Series

ECMA Series	C $\Delta$ 06	C $\Delta$ 08	E $\Delta$ 13			F $\Delta$ 13	G $\Delta$ 13		
	04 $\square$ H	07 $\square$ H	05	10	15	08	03	06	09
Rated output power (kW)	0.4	0.75	0.5	1.0	1.5	0.85	0.3	0.6	0.9
Rated torque (N-m) <sup>*1</sup>	1.27	2.39	2.39	4.77	7.16	5.41	2.86	5.73	8.59
Maximum torque (N-m)	3.82	7.16	7.16	14.3	21.48	13.8	8.59	17.19	21.48
Rated speed (r/min)	3000	3000	2000			1500	1000		
Maximum speed (r/min)	5000	5000	3000			3000	2000		
Rated current (A)	2.6	5.1	2.9	5.6	8.3	7.1	2.5	4.8	7.5
Maximum current (A)	7.8	15.3	8.7	16.8	24.9	19.4	7.5	14.4	22.5
Power rating (kW/s)	21.7	19.63	7.0	27.1	45.9	21.52	10.0	39.0	66.0
Rotor moment of inertia (x10 <sup>-4</sup> kg-m <sup>2</sup> )(without brake)	0.743	2.91	8.17	8.41	11.18	13.6	8.17	8.41	11.18
Mechanical time constant (ms)	1.42	1.6	1.91	1.51	1.10	2.43	1.84	1.40	1.06
Torque constant-KT (N-m/A)	0.49	0.47	0.83	0.85	0.87	0.76	1.15	1.19	1.15
Voltage constant-KE (mV/(r/min))	17.4	17.2	30.9	31.9	31.8	29.2	42.5	43.8	41.6
Armature resistance (Ohm)	1.55	0.42	0.57	0.47	0.26	0.38	1.06	0.82	0.43
Armature inductance (mH)	6.71	3.53	7.39	5.99	4.01	4.77	14.29	11.12	6.97
Electrical time constant (ms)	4.3	8.36	12.96	12.88	15.31	12.55	13.55	13.50	16.06
Insulation class	A class (UL), B class (CE)								
Insulation resistance	100M $\Omega$ , DC 500V								
Insulation strength	1.8k V <sub>AC</sub> , 1 sec								
Weight (kg)(without brake)	1.8	3.4	6.8	7.0	7.5	8.6	6.8	7.0	7.5
Weight (kg)(with brake)	2.2	3.9	8.2	8.4	8.9	10.0	8.2	8.4	8.9
Max. radial shaft load (N)	196	245	490	490	490	490	490	490	490
Max. thrust shaft load (N)	68	98	98	98	98	98	98	98	98
Power rating (kW/s)(with brake)	21.48	19.3	6.4	24.9	43.1	19.78	9.2	35.9	62.1
Rotor moment of inertia (x10 <sup>-4</sup> kg-m <sup>2</sup> )(with brake)	0.751	2.96	8.94	9.14	11.90	14.8	8.94	9.14	11.9
Mechanical time constant (ms)(with brake)	1.43	1.62	2.07	1.64	1.19	2.65	2.0	1.51	1.13
Brake holding torque [N·m (min)] <sup>*2</sup>	1.3	1.3	10.0	10.0	10.0	10.0	10.0	10.0	10.0
Brake power consumption (at 20°C)[W]	6.5	6.5	19.0	19.0	19.0	19.0	19.0	19.0	19.0
Brake release time [ms (Max)]	10	10	10	10	10	10	10	10	10
Brake pull-in time [ms (Max)]	70	70	70	70	70	70	70	70	70
Vibration grade ( $\mu$ m)	15								
Operating temperature (°C)	0°C ~ 40°C (32°F ~ 104°F)								
Storage temperature (°C)	-10°C ~ 80°C (-14°F ~ 176°F)								
Operating humidity	20 ~ 90%RH (non-condensing)								
Storage humidity	20 ~ 90%RH (non-condensing)								
Vibration capacity	2.5G								
IP Rating	IP65 (when waterproof connectors are used, or when an oil seal is used to be fit to the rotating shaft)								
Approvals									

\*1 Rate torque values are continuous permissible values at 0 ~ 40°C ambient temperature when attaching with the sizes of heatsinks listed below:

ECMA-\_\_ 04 / 06 / 08: 250 mm x 250 mm x 6 mm

ECMA-\_\_ 10: 300 mm x 300 mm x 12 mm

ECMA-\_\_ 13: 400 mm x 400 mm x 20 mm

Material: Aluminum – F40, F60, F80, F100, F130

\*2 The holding brake is for holding the motor shaft, not for decelerating or stopping the machine

# Handheld HMI

## DOP-H Series



## Dimensions

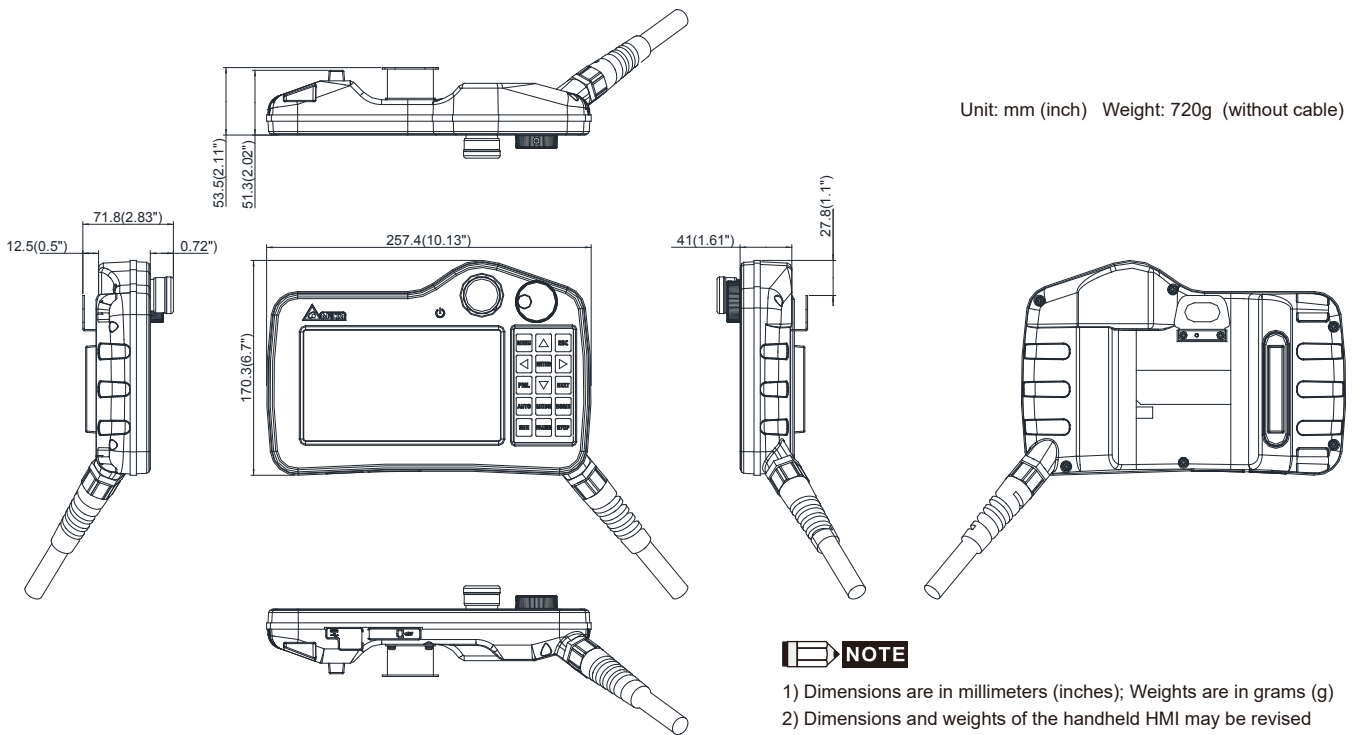

# Specifications

Model	DOP-H07E425ZM	DOP-H07E465ZM
LCD Module	Display Size & Type	7" Widescreen TFT LCD
	Display Colors	65536 colors
	Resolution (pixels)	800 x 480
	Backlight	LED Back Light
	Luminance (cd/m2)	450
	Backlight Life <sup>*1</sup> (hours)	20,000
MCU	400 MHz	
Flash ROM(Bytes)	128MB	
RAM(Bytes)	64MB	
Backup Memory (Bytes)	16MB	
Buzzer	Multi-Tone Frequency (2K ~ 4K Hz) / 80dB	
Audio Output	N/A	
USB	1 USB Client Ver 2.0	
SD	SD Card (Supports SDHC)	
Serial COM Port	N/A	
Ethernet	1 Ports <sup>*2</sup>	
Function Key	15	
Cable Length & Type	5 m	
Emergency Stop	A-contact: B-contact: 1 Rated voltage: DC 24V Max. rated current: 500mA Min. allowable load: DC 5V / 1mA Complies with IEC60947-5-1, EN60947-5-1, IEC60947-5-5, EN60947-5-5, UL 508, CSA C22.2 No.14, GB 14085.5	
3-Position Operation Switch	A-contact: 1 Rated voltage: DC 24V Max. rated current: 500mA Min. allowable load: DC 3V/5mA Complies with EN/IEC60947-5-8, IEC60947-5-1, EN60947-5-1, JIS C8201-5-1, UL508, CSA C22.2 NO. 14 Applicable standards for use with ISO12100-1, -2 / EN12100-1, -2, IEC60204-1/EN60204-1, ISO11161/prEN11161, ISO10218/EN775, ANSI/RIA R15.06, ANSI B11.19	
Handwheel	N/A	Rated Voltage: < DC 24V in Resolution: 50 (P/R) Output Pulse: Square Output Phase: A, B Phase difference of A and B: 90° ± 45° Max. Frequency response: 200 Hz
Perpetual Calendar	Built-in	
Cooling Method	Natural cooling	
Safety Approval	CE <sup>*4</sup>	
Waterproof Level of Panel Display	IP55	
Operation Voltage <sup>*3</sup>	DC + 24V(-10% ~ +15%)	
Voltage Endurance	AC500V for 1 minute (between charging DC24V terminal and FG terminals)	
Power Consumption <sup>*5</sup>	5.6W	
Backup Battery	3V lithium battery CR2450 × 1	
Backup Battery Life	About 5 years or more at 25°C but subjects to the temperature and the conditions during usage.	
Operation Temperature	0°C ~ 40°C	
Storage Temperature	-20°C ~ +60°C, 10% ~ 90% RH	
Operating Environment	10% ~ 90% RH [0 ~ 40°C] ; 10% ~ 55% RH [41 ~ 50°C] ; Pollution Degree 2	
Vibration	Conforms to IEC61131-2; Continuous: 5Hz ~ 8.3Hz 3.5 mm, 8.3Hz ~ 150Hz 1G	
Shock	Conforms to IEC60068-2-27; 11ms, 15G Peak , X, Y, Z direction for 6 times	
Dimensions ( W ) x ( H ) x ( D ) mm	257.4 x 170.3 x 71.8 (emergency stop switch and hook included)	
Weight	750g (cable excluded)	

\*1 The half-life of backlight is defined as original luminance being reduced by 50% when the maximum driving current is supplied to HMI

\*2 With built-in isolated power circuit

\*3 Please use isolated power supply

\*4 Some models are in the process of application for UL and KCC certification. For more information, please consult our distributors

\*5 The value of the power consumption indicates the electrical power consumed by HMI with no peripheral devices connected. To ensure normal operation, it is recommended to use a power supply with a capacity 1.5 ~2 times the value of the power consumption

\*6 The content of this catalogue may be revised without prior notice. Please consult our distributors or download the most updated version at <http://www.deltaww.com>

# Optional Accessories

## Power Connectors (for both A2 & A3 Series)

ASDBCAPW0000

(for servo motors with 40/60/80/86 frame size)

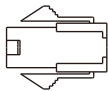

Title	Part No.	Manufacturer
Housing	C4201H00-2*2PA	JOWLE
Terminal	C4201TOP-2	JOWLE

ASD-CAPW1000

(for servo motors with 100/130 frame size)

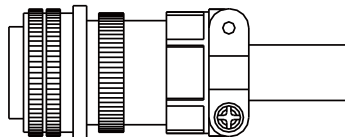

3106A-20-18S

ASDBCAPW0100

(for servo motors with 40/60/80/86 frame size and brake cable)

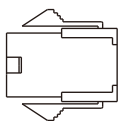

Title	Part No.	Manufacturer
Housing	C4201H00-2*3PA	JOWLE
Terminal	C4201TOP-2	JOWLE

## Encoder Connectors

ASD-ABEN0000

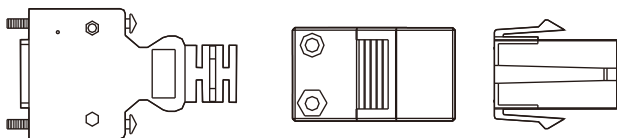

	Title	Part No.	Manufacturer
MOTOR SIDE	Housing	AMP (1-172161-9)	AMP
	Terminal	AMP (170359-3)	AMP
	CLAMP	DELTA (34703237XX)	DELTA
DRIVE SIDE	PLUG	3M 10120-3000PE	3M
	SHELL	3M 10320-52A0-008	3M

ASD-CAEN1000

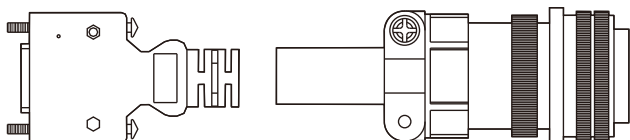

	Title	Part No.	Manufacturer
MOTOR SIDE		3106A-20-29S	-----
DRIVE SIDE	PLUG	3M 10120-3000PE	3M
	SHELL	3M 10320-52A0-008	3M

## Absolute Encoder Cables

ACS3-CAEA1003 / ACS3-CAEA1005

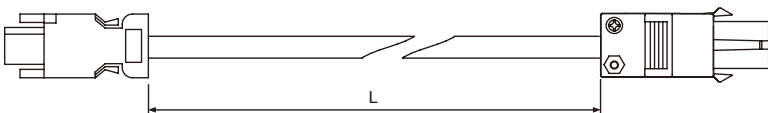

Item	Part No.	L	
		mm	inch
1	ACS3-CAEA1003	3000 ± 100	118 ± 4
2	ACS3-CAEA1005	5000 ± 100	197 ± 4

ACS3-CAEA3003 / ACS3-CAEA3005

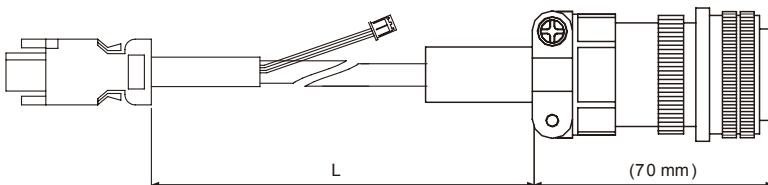

Item	Part No.	L	
		mm	inch
1	ACS3-CAEA3003	3000 ± 100	118 ± 4
2	ACS3-CAEA3005	5000 ± 100	197 ± 4

# Optional Accessories

## Incremental Encoder Cables

ACS3-CAEN1003 / ACS3-CAEN1005

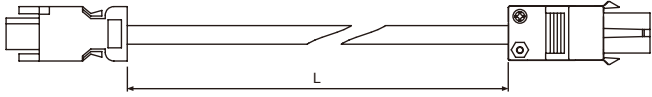

Item	Part No.	Straight	L	
			mm	inch
1	ACS3-CAEN1003	3106A-20-29S	3000 ± 100	118 ± 4
2	ACS3-CAEN1005	3106A-20-29S	5000 ± 100	197 ± 4

ACS3-CAEN3003 / ACS3-CAEN3005

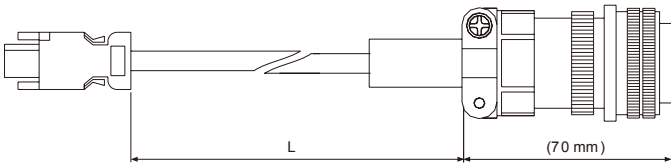

Item	Part No.	Straight	L	
			mm	inch
1	ACS3-CAEN3003	3106A-20-29S	3000 ± 100	118 ± 4
2	ACS3-CAEN3005	3106A-20-29S	5000 ± 100	197 ± 4

## Battery Box Cord AW (Connects to the battery side of the encoder cable)

Model number: 3864573700

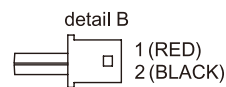
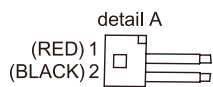
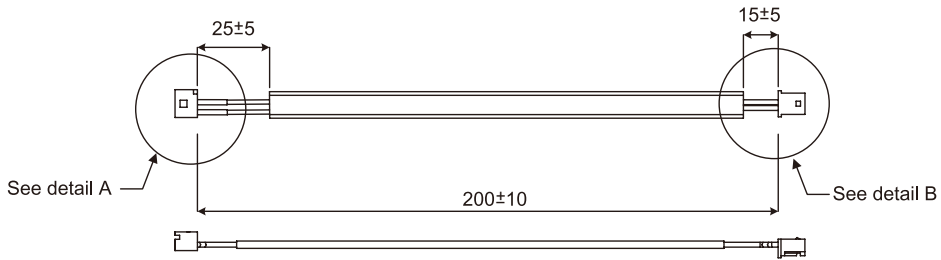

Unit: mm

## Battery Boxes with batteries

Single-battery Type

ASD-MDBT0100

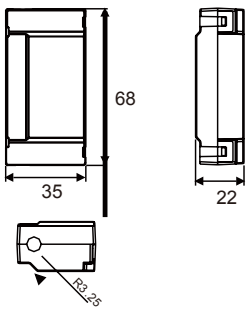

Dual-battery Type

ASD-MDBT0200

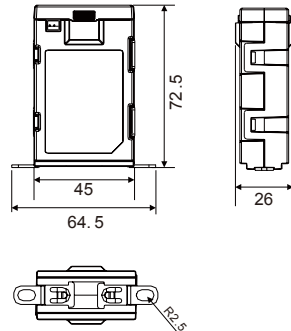

Unit: mm

## Optional Accessories

Title	Type	Part No.
Terminal Accessory Kit	Standard I/O Terminal (STD.DIO) Main Circuit Terminal (R,S,T) Control Circuit Terminal (24V) Servo Motor Output (U,V,W) 2 Set STO Connector Motor Brake Output Terminal STO I/O Terminal (Safe Torque Off) System I/O Terminal (SYS.DIO) Motor Encoder Interface (MOTOR. ENC.) Full-Closed Loop Control Interface (EXT.ENC)	GMC-MS00AC
Servo Motor Encoder Connector	Quick Connector	ASD-ABEN0000
	Military Connector	ASD-CAEN1000
Servo Motor Power Connector	Non Quick Release Connector	ASDBCAPW0000
	Quick Release Connector	ASDBCAPW0100
	Military Connector	ASD-CAPW1000
DMCNET Extension IO Module	DMCNET Extension Module 32 DI (NPN//PNP)	ASD-DMC-RM32MN
	DMCNET Extension Module 32 DO Transistor Output	ASD-DMC-RM32NT
	DMCNET Extension Module 64 DI (NPN//PNP)	ASD-DMC-RM64MN
	DMCNET Extension Module 64 DO Transistor Output	ASD-DMC-RM64NT
	DMCNET Extension Module 16 DI/ 16 DO Transistor Output	ASD-DMC-RM32PT
	DMCNET Extension Module with 4 sets of analog input	ASD-DMC-RM04AD
	DMCNET Extension Module with 4 sets of analog output	ASD-DMC-RM04DA
	DMCNET Extension Module with 4 sets of pulse output	ASD-DMC-RM04PI

DMCNET Communication Cables	
NC-CAB-DMC003	DMCNET and Servo Drives Cables (0.3 m)
NC-CAB-DMC015	DMCNET and Servo Drives Cables (1.5 m)
NC-CAB-DMC030	DMCNET and Servo Drives Cables (3.0 m)
NC-CAB-DMC050	DMCNET and Servo Drives Cables (5.0 m)
NC-CAB-DMC100	DMCNET and Servo Drives Cables (10.0 m)
ASD-TR-DM0008	DMCNET Bus-way Terminal Communication Resistance (optional)





**ASIA (Taiwan)**



Taoyuan Technology Center (Green Building)



Taoyuan Plant 1



Tainan Plant (Diamond-rated Green Building)



Wujiang Plant 3



Shanghai Office

**ASIA (China)**



**ASIA (Japan)**



Tokyo Office

**ASIA (India)**



Rudrapur Plant  
(Green Building)

**EUROPE**



Amsterdam, the Netherlands

**AMERICA**



Research Triangle Park, U.S.A.

▲ 6 Factories   ■ 117 Branch Offices   ● 13 R&D Centers   ■ 915 Distributors

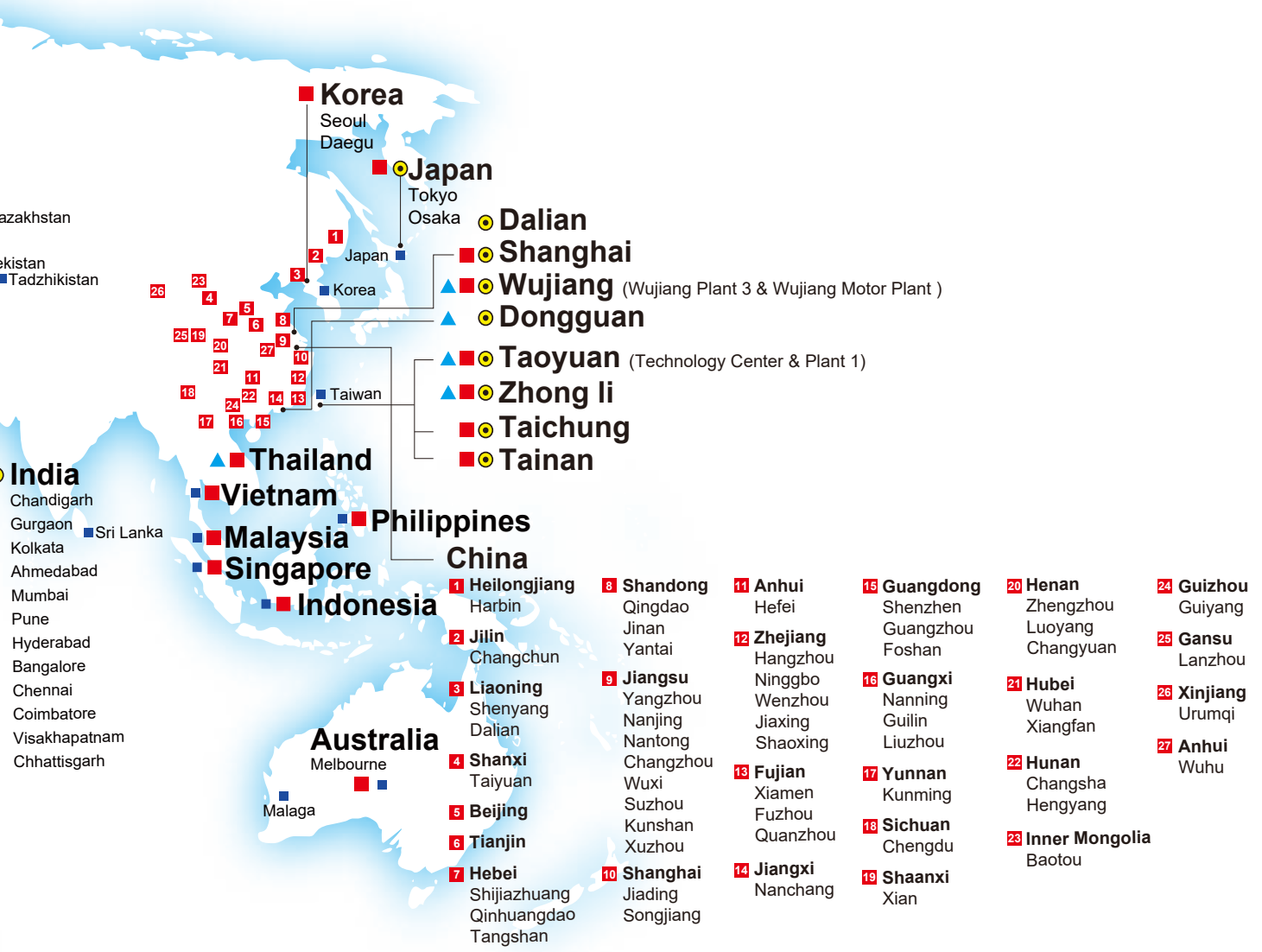



Smarter. Greener. Together.

## Industrial Automation Headquarters

### Delta Electronics, Inc.

Taoyuan Technology Center  
No.18, Xinglong Rd., Taoyuan District,  
Taoyuan City 33068, Taiwan  
TEL: 886-3-362-6301 / FAX: 886-3-371-6301

## Asia

### Delta Electronics (Shanghai) Co., Ltd.

No.182 Minyu Rd., Pudong Shanghai, P.R.C.  
Post code : 201209  
TEL: 86-21-6872-3988 / FAX: 86-21-6872-3996  
Customer Service: 400-820-9595

### Delta Electronics (Japan), Inc.

Tokyo Office  
Industrial Automation Sales Department  
2-1-14 Shibadaimon, Minato-ku  
Tokyo, Japan 105-0012  
TEL: 81-3-5733-1155 / FAX: 81-3-5733-1255

### Delta Electronics (Korea), Inc.

Seoul Office  
1511, 219, Gasan Digital 1-Ro., Geumcheon-gu,  
Seoul, 08501 South Korea  
TEL: 82-2-515-5305 / FAX: 82-2-515-5302

### Delta Energy Systems (Singapore) Pte Ltd.

4 Kaki Bukit Avenue 1, #05-04, Singapore 417939  
TEL: 65-6747-5155 / FAX: 65-6744-9228

### Delta Electronics (India) Pvt. Ltd.

Plot No.43, Sector 35, HSIIDC Gurgaon,  
PIN 122001, Haryana, India  
TEL: 91-124-4874900 / FAX : 91-124-4874945

### Delta Electronics (Thailand) PCL.

909 Soi 9, Moo 4, Bangpoo Industrial Estate (E.P.Z),  
Pattana 1 Rd., T.Phraksa, A.Muang,  
Samutprakarn 10280, Thailand  
TEL: 66-2709-2800 / FAX : 662-709-2827

### Delta Energy Systems (Australia) Pty Ltd.

Unit 20-21/45 Normanby Rd., Notting Hill Vic 3168, Australia  
TEL: 61-3-9543-3720

## Americas

### Delta Electronics (Americas) Ltd.

Raleigh Office  
P.O. Box 12173, 5101 Davis Drive,  
Research Triangle Park, NC 27709, U.S.A.  
TEL: 1-919-767-3813 / FAX: 1-919-767-3969

### Delta Greentech (Brasil) S/A

São Paulo Office  
Rua Itapeva, 26 – 3º Andar - Bela Vista  
CEP: 01332-000 – São Paulo – SP - Brasil  
TEL: 55-11-3530-8642 / 55-11-3530-8640

### Delta Electronics International Mexico S.A. de C.V.

Mexico Office  
Vía Dr. Gustavo Baz No. 2160, Colonia La Loma,  
54060 Tlalnepanitla Estado de Mexico  
TEL: 52-55-2628-3015 #3050/3052

## EMEA

### Headquarters: Delta Electronics (Netherlands) B.V.

Sales: Sales.IA.EMEA@deltaww.com  
Marketing: Marketing.IA.EMEA@deltaww.com  
Technical Support: iatechnicalsupport@deltaww.com  
Customer Support: Customer-Support@deltaww.com  
Service: Service.IA.emea@deltaww.com  
TEL: +31(0)40 800 3800

### BENELUX: Delta Electronics (Netherlands) B.V.

De Witbogt 20, 5652 AG Eindhoven, The Netherlands  
Mail: Sales.IA.Benelux@deltaww.com  
TEL: +31(0)40 800 3800

### DACH: Delta Electronics (Netherlands) B.V.

Coesterweg 45, D-59494 Soest, Germany  
Mail: Sales.IA.DACH@deltaww.com  
TEL: +49(0)2921 987 0

### France: Delta Electronics (France) S.A.

ZI du bois Challand 2, 15 rue des Pyrénées,  
Lisses, 91090 Evry Cedex, France  
Mail: Sales.IA.FR@deltaww.com  
TEL: +33(0)1 69 77 82 60

### Iberia: Delta Electronics Solutions (Spain) S.L.U

Ctra. De Villaverde a Vallecas, 265 1º Dcha Ed.  
Hormigueras – P.I. de Vallecas 28031 Madrid  
TEL: +34(0)91 223 74 20

Carrer Llacuna 166, 08018 Barcelona, Spain

Mail: Sales.IA.Iberia@deltaww.com

### Italy: Delta Electronics (Italy) S.r.l.

Ufficio di Milano Via Senigallia 18/2 20161 Milano (MI)  
Piazza Grazioli 18 00186 Roma Italy  
Mail: Sales.IA.Italy@deltaww.com  
TEL: +39 02 64672538

### Russia: Delta Energy System LLC

Vereyskaya Plaza II, office 112 Vereyskaya str.  
17 121357 Moscow Russia  
Mail: Sales.IA.RU@deltaww.com  
TEL: +7 495 644 3240

### Turkey: Delta Greentech Elektronik San. Ltd. Sti. (Turkey)

Şerifaii Mah. Hendem Cad. Kule Sok. No:16-A  
34775 Ümraniye – İstanbul  
Mail: Sales.IA.Turkey@deltaww.com  
TEL: + 90 216 499 9910

### GCC: Delta Energy Systems AG (Dubai BR)

P.O. Box 185668, Gate 7, 3rd Floor, Hamarain Centre  
Dubai, United Arab Emirates  
Mail: Sales.IA.MEA@deltaww.com  
TEL: +971(0)4 2690148

### Egypt + North Africa: Delta Electronics

511 Cairo Business Plaza, North 90 street,  
New Cairo, Cairo, Egypt  
Mail: Sales.IA.MEA@deltaww.com