



Digitized Automation for a Changing World

Delta PC-Based Motion Controller PAC Total Solution

www.deltaww.com

 **DELTA**
Smarter. Greener. Together.



Delta PC-Based Motion Controller PAC Total Solution

Delta's PAC platform is a solution with high reliability, integrated network communication capability, and high-end motion control functions, and is ideal for advanced automation machining. Through EtherCAT or DMCNET communication, the platform is able to perform high-response, high-precision, and synchronous multi-axis motion control with easy and flexible operation.

Its cable-less and fan-less design enhances reliability and resistance for harsh environments and contaminants. It is also implemented with an X86 dual-core processor and EtherCAT or DMCNET communication that enables faster and more convenient data transmission.

With the built-in dynamic-link library (DLL), the controller of the platform effectively simplifies the implementation process and saves development time. In addition, the integrated versatile software of the platform provides a perfect integration of logic programming control (with SoftPLC), human machine interface (with SoftHMI), numeric control and robot control, supporting IEC61131-3 programming languages and high performance motion control for a wide range of applications and industries.

Delta's PAC platform offers a comprehensive, highly integrated, and easy industrial PC-based motion control solution to help optimize customers' competitiveness with capabilities for getting ahead of the game.

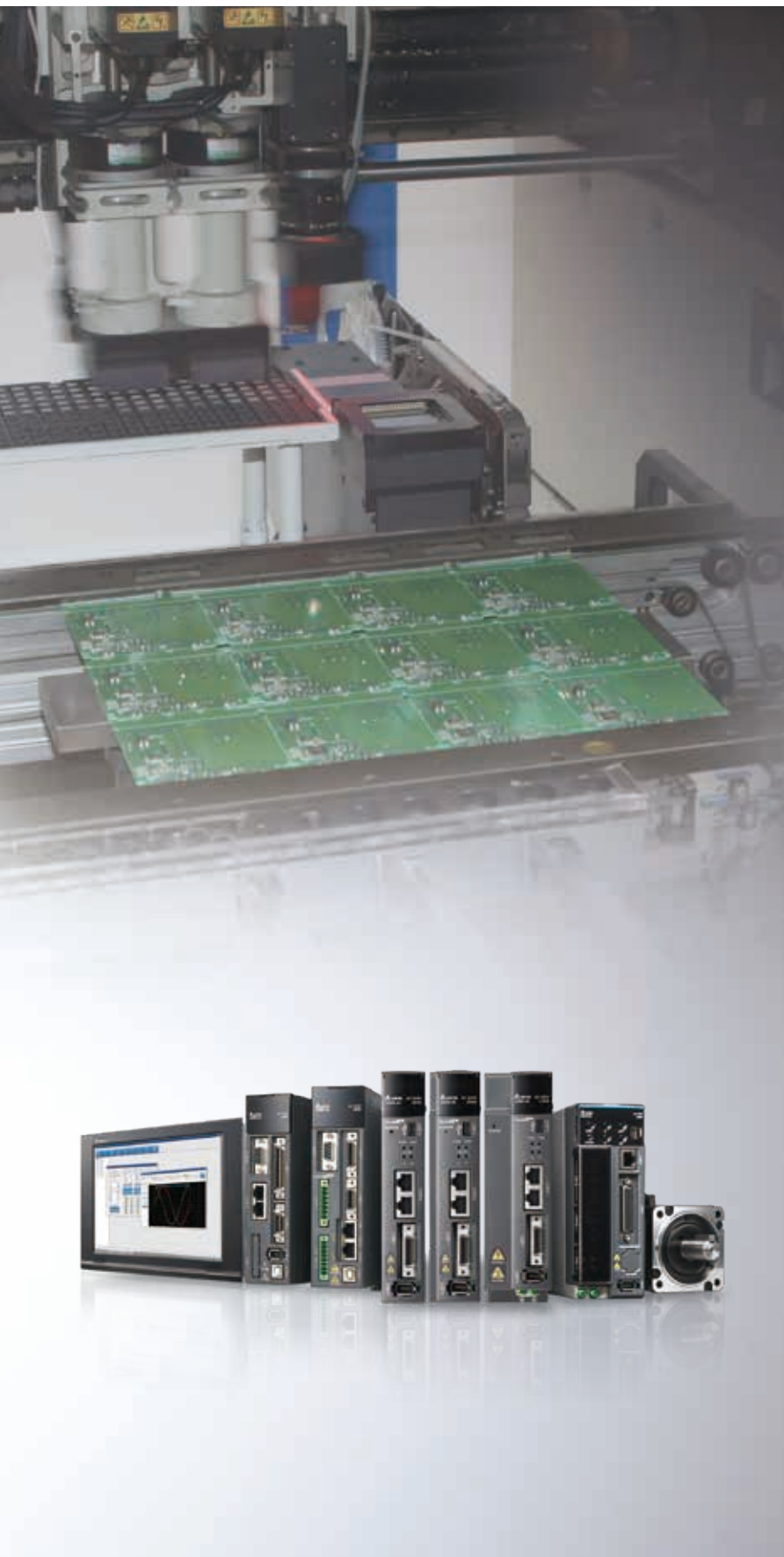





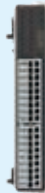

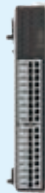



Table of Contents

Introduction	1
EtherCAT System Structure	3
PAC under EtherCAT Structure	
EcNavi Software	
DMCNET System Structure	7
PAC under DMCNET Structure	
EzDMC Software	
Product Information	11
MH2 Series	
MP1-P10D-15 Series	
EtherCAT Remote Modules	15
DMCNET Remote Modules	23
Ordering Information	29

EtherCAT System Structure

Motion Controllers				
PC-based controller		MH2 Series	Refer to p.11 for details.	
Servo Systems				
AC Servo Drive	ASDA-A3-E 	ASDA-A2-E 	ASDA-B3-E 	
** Please refer to the catalogues of Delta's servo drives and motors ASDA Series for detailed specifications				
Gateway Type Remote Modules	Pulse Remote Module			
 R1-EC5500D0 Refer to p.15 for details.	 1-Channel Pulse Remote Module R1-EC5621D0 Refer to p.16 for details.			
	Digital Remote Modules			
	16 Digital Input Remote Module R1-EC6002D0 R1-EC6022D0		16 Digital Input Remote Module R1-EC7062D0 R1-EC70A2D0 R1-EC70E2D0 R1-EC70F2D0	Remote Module R2-EC0902D0  Refer to p.17~19 for details.
	Analog Remote Modules			
	4-Channel Analog Input Remote Module R1-EC8124D0		4-Channel Analog Output Remote Module R1-EC9144D0	Refer to p.20~21 for details.
Functional Remote Modules				
For Manual Pulse Generator (MPG) R1-EC5614D0			Refer to p.22 for details.	

High-Speed Motion Control System - EtherCAT

Ethernet Central Automation Technology (EtherCAT) is an open Ethernet-based fieldbus system that provides high-efficiency and high-performance synchronization quality for automation control. Delta's EtherCAT motion control solution achieves rapid and real-time multiple axes of motion control, and is capable of controlling up to 100 slave stations that enable a 64-axis motion control within 1ms cycle time. It also provides 35 homing modes, point-to-point position control, 2-axis interpolation, 3-axis interpolation, multi-axis synchronization, continuous motion, gantry control, speed control, torque control, ECAM and Motion Buffer functions.

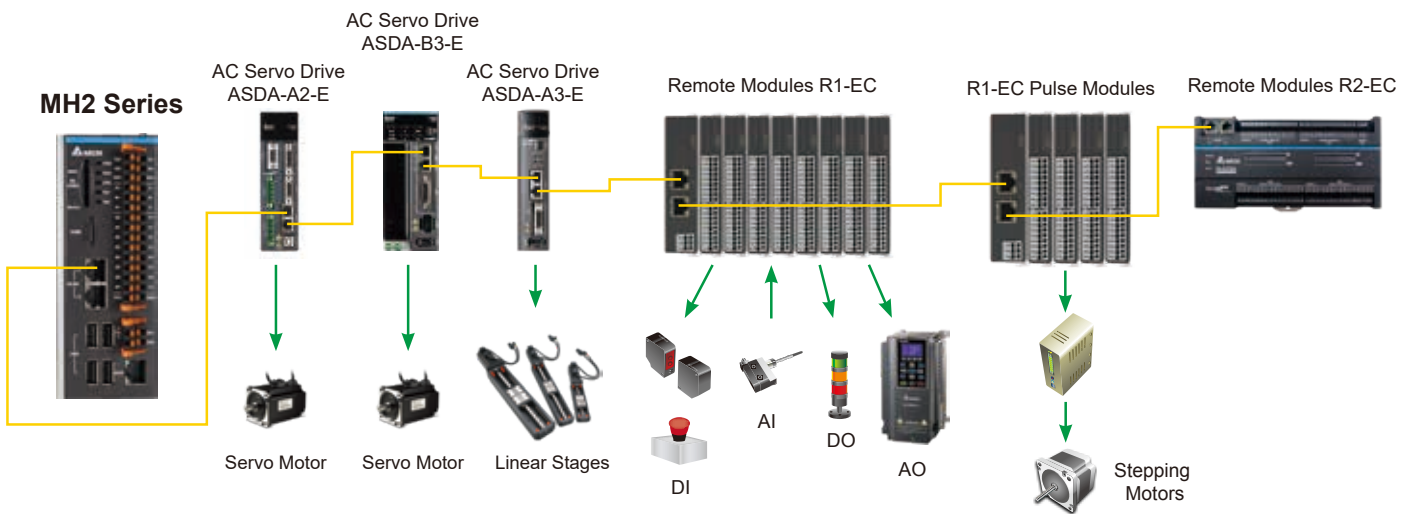

EtherCAT Motion Control Structure

Delta provides a rugged and high-speed motion control solution with complete functions for EtherCAT masters, and that supports device description in XML format (EtherCAT Slave Information - ESI) that are useful for EtherCAT device development.

Delta's EtherCAT motion control solution also allows the system to quickly identify ESI files and offers the capability of real-time connection via EtherCAT for high-level integration. Its rapid communication can update commands between stations within 1 ms~0.125ms to ensure accurate and prompt data transfer within the network.

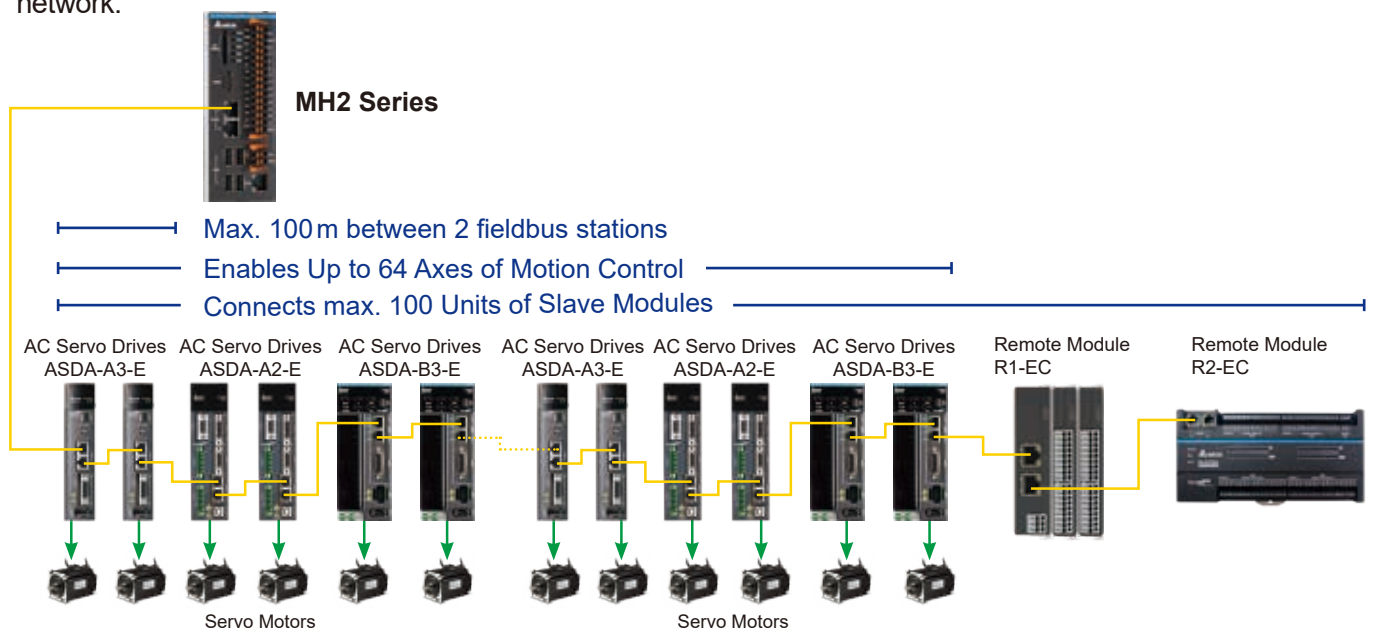

Fieldbus Verification and Validation - EcNavi Software

► EtherCAT Automation Software

EcNavi development software is for configuring an EtherCAT network that includes an EtherCAT master controller and slave devices for data communication, functional identification, programming and debugging. For new users of Delta's EtherCAT motion control, the EcNavi helps them become familiar with the configuration of the system and to complete the function verification and validation in real time.

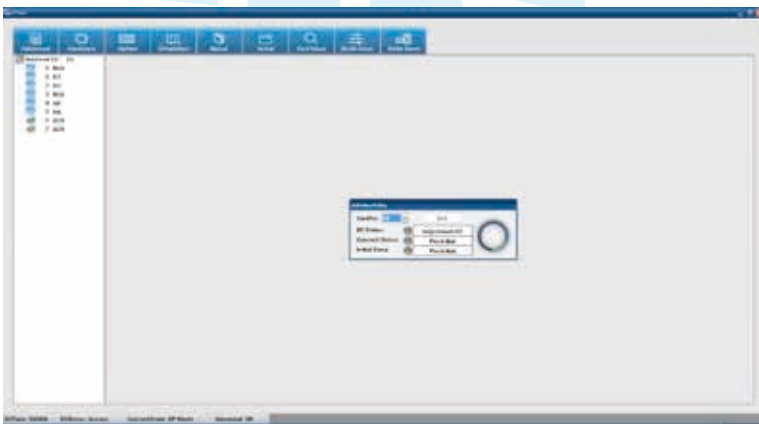

► Hardware Structure Search

Provides search function for all slaves connected by EtherCAT to check hardware configuration and verify whether the network communication is established successfully via software

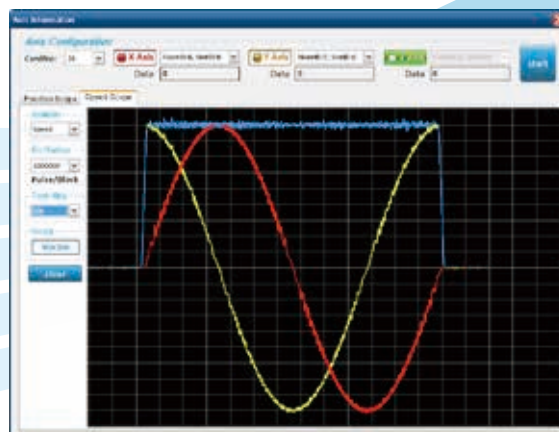

► Speed Curve Tracing

Offers real-time tracing for speed curves of current motion commands to achieve better synchronization effects between multiple axes

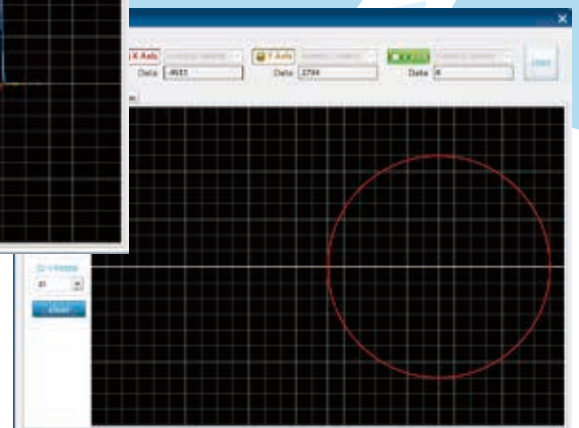



► Independent Control Unit















Helps users avoid writing complex programs and immediately verifies all motion commands with the servo drives to meet application requirements

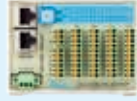

► Multi-Axis Motion Control Mode

Offers a variety of sample programs and control modes for EtherCAT devices (e.g. Linear 2, Linear 3, Heli, Circle, Circle 2 and Circle 3) to help users easily edit and complete development programs for multi-axis motion control applications

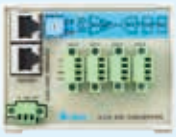
DMCNET System Structure

Motion Controllers	<p>PC-based Controller</p>  <p>MP1 Series</p> <p style="text-align: right;">Refer to p.13 for details.</p>
Servo Systems	<p>Servo Motors and Drives</p>      <p>ASDA-A3-F ASDA-A2-F ASDA-B3-F ASDA-B2-F ASDA-M</p> <p><small>** Please refer to the catalogues of Delta's servo drives and motors ASDA Series for detailed specifications</small></p>
Digital Remote Modules	   <p>32 Digital Input Remote Module ASD-DMC-RM32MN 64 Digital Input Remote Module ASD-DMC-RM64MN Digital I/O Remote Module HMC-RIO3232RT5</p>    <p>32 Digital Output Remote Module ASD-DMC-RM32NT 64 Digital Output Remote Module ASD-DMC-RM64NT 32 Digital I/O Remote Module ASD-DMC-RM32PT</p> <p style="text-align: right;">Refer to p.23~25 for details.</p>
Pulse Remote Module	 <p>4-Channel Pulse Remote Module ASD-DMC-RM04PI</p> <p style="text-align: right;">Refer to p.26 for details.</p>
Analog Remote Modules	  <p>4-Channel Analog Output Remote Module ASD-DMC-RM04DA 4-Channel Analog Input Remote Module ASD-DMC-RM04AD</p> <p style="text-align: right;">Refer to p.27 for details.</p>
Gateway Type Remote Modules	  <p>Gateway Type Remote Power Coupler ASD-DMC-GA01 Gateway Type 1-Channel Pulse Remote Module ASD-DMC-GE01PH</p> <p style="text-align: right;">Refer to p.28 for details.</p>

Delta's High-Speed Motion Control System - DMCNET

Delta's Motion Control NETWORK (DMCNET) is a high speed, real-time communication system, capable of controlling up to 12 axes of servo system units within 1ms simultaneously: with 3-axis helical and linear interpolation in 4 groups, or 2-axis linear and arc interpolation in 6 groups. It supports 64-bit dual-precision floating point, allowing high-precision system calculations and flexible operation, and also absolute commands, incremental commands and T-curve / S-curve velocity profiles for different uses. With built-in position, speed and torque control modes, and 35 homing modes, it is able to receive real-time servo information, parameters, or change control modes via communication command, offering fast communication and motion control for various applications

DMCNET Motion Control Structure

In addition to a one-wire communication protocol, the DMCNET also provides various options, such as 6-axis PCI-DMC-F02, 12-axis PCI-DMC-A02, and the PCI-DMC-B01 with pulse compare & capture functions. Based on user requirements, the servo drive can be combined with Servo Motor ASDA-A3-F Series, ASDA-A2-F Series, ASDA-B2-F Series or ASDA-B3-F Series. Delta helps users achieve best product performance and value with minimum investment

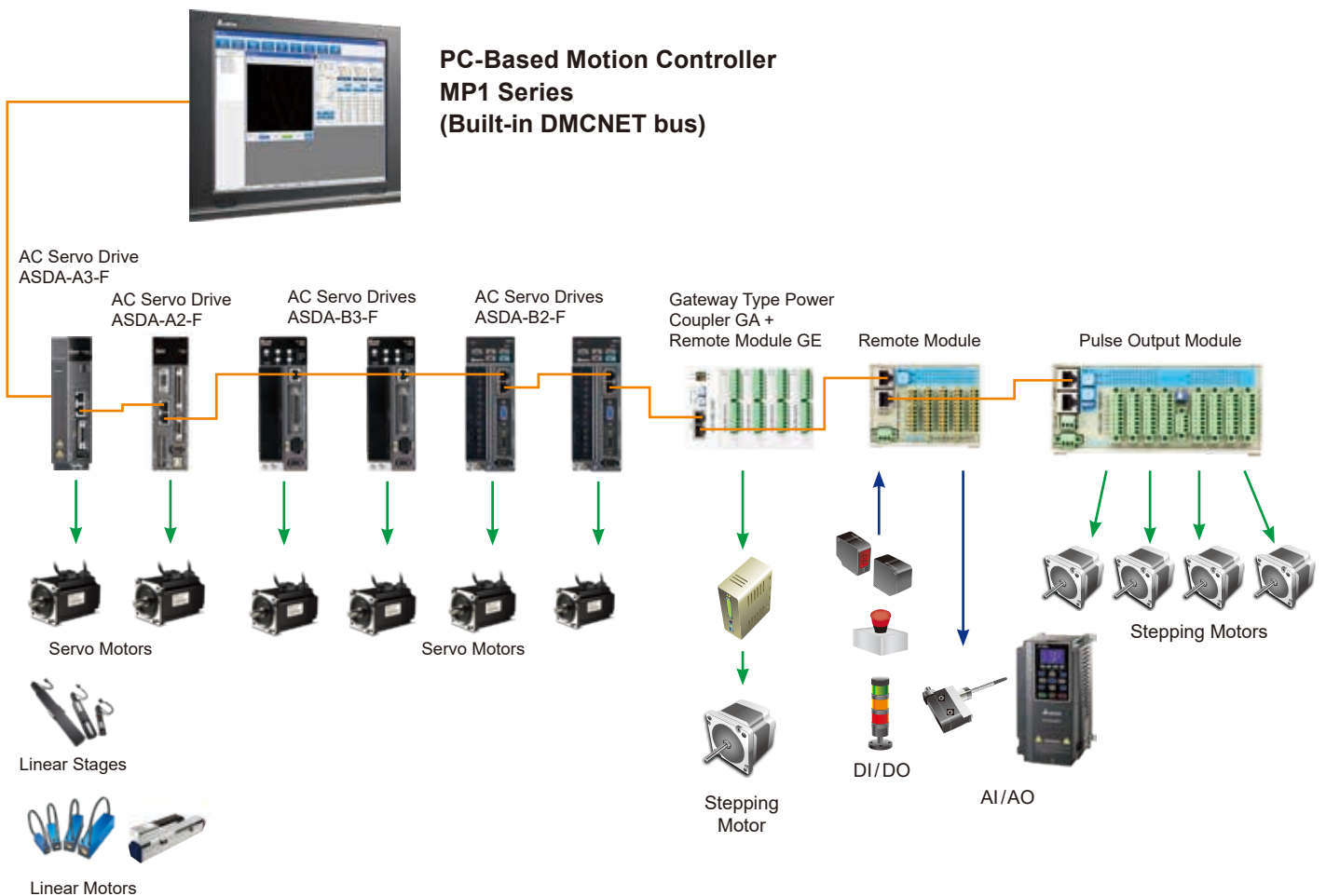

Fieldbus Verification and Validation - EzDMC Software

EzDMC Software provides simple editing functions for all the relevant parameters of the fieldbus communication and facilitates program development and a hardware system that is easily configurable. Even first time users of Delta's DMCNET motion control cards can utilize the motion control card functions.

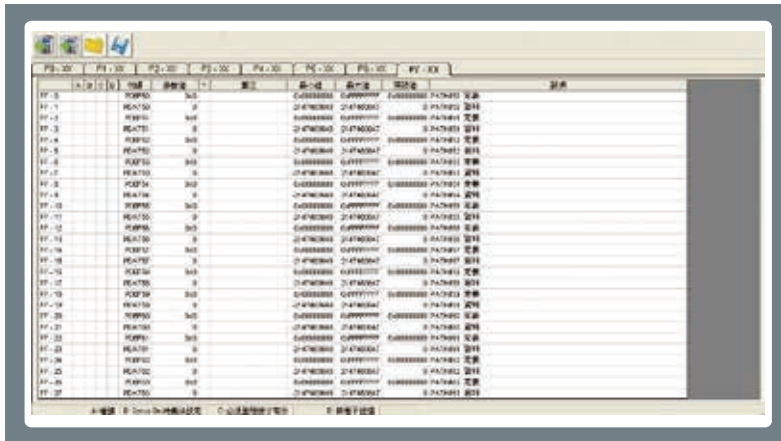

► User-Friendly Operation Interface

Helps users create and edit programs with clear images, easy-to-use parameter settings, and instruction disk for programming samples and function keys explanation

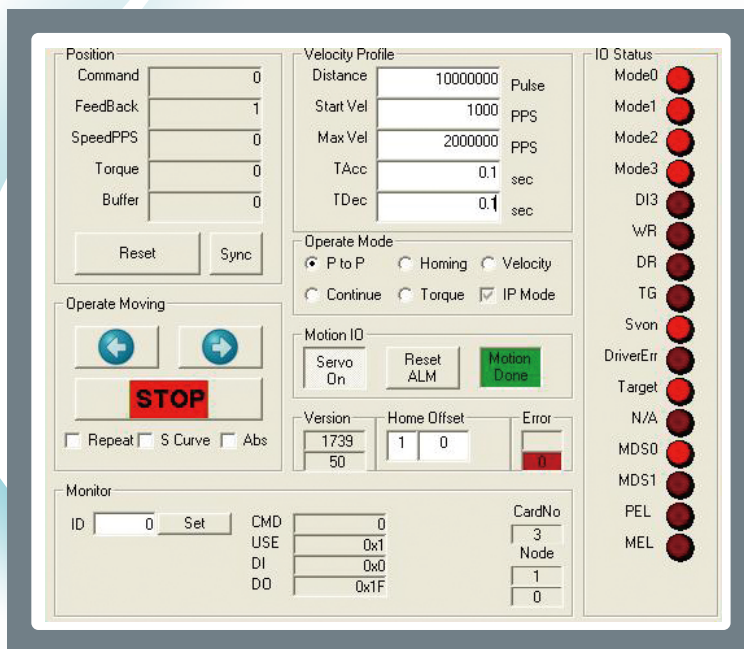

► Independent Control Unit

With the independent control unit, users can set up simple motions of the servo drives for flexible operation and management

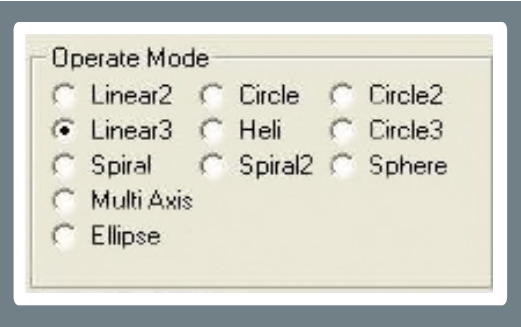

► **Multi-Axis Motion Control Modes**

Offers a variety of sample programs and control modes (e.g. Linear 2, Linear 3, Heli, Circle, Circle 2 and Circle 3) for linear, arc and helical interpolation to supervise various multi-axis motions and execute programming for multi-axis motion control applications

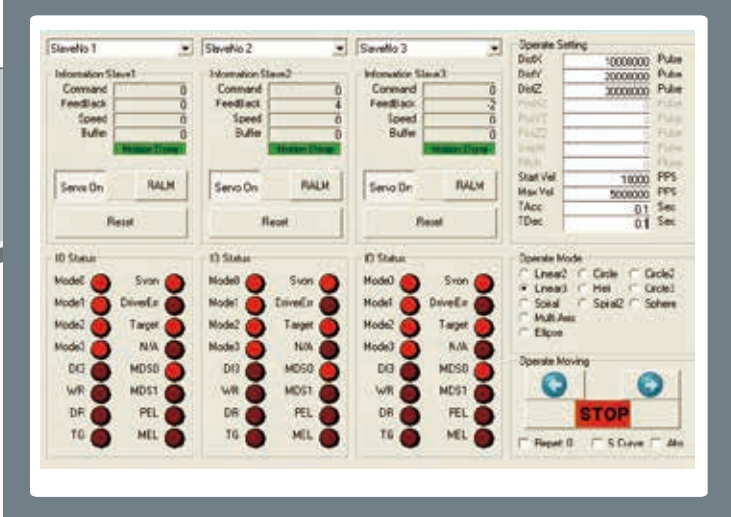
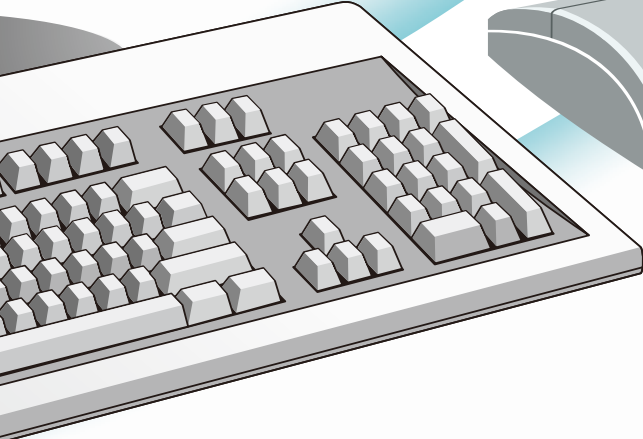

► **Real Time Response and Feedback**

Monitoring and displaying the status of the connected servo drives is completed in a timely and efficient manner

Dimensions

MH2-P10N

- ▶ Dimensions: 54.2 mm (W) × 141 mm (H) × 137.5 mm (L)
- ▶ Dimensions (Accessories included): 54.2 mm (W) × 164 mm (H) × 166.8 mm (L)

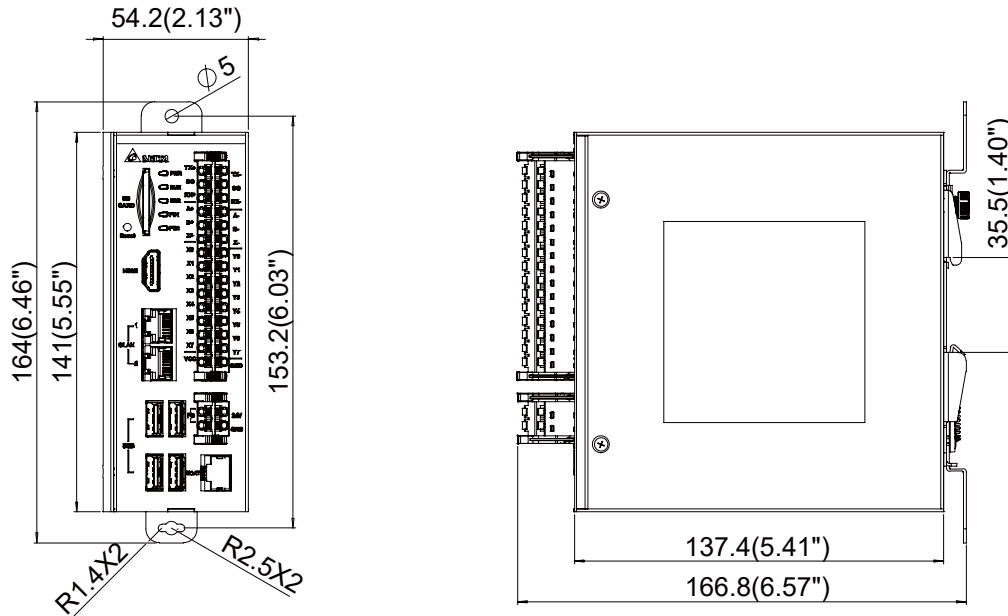

Exterior Description

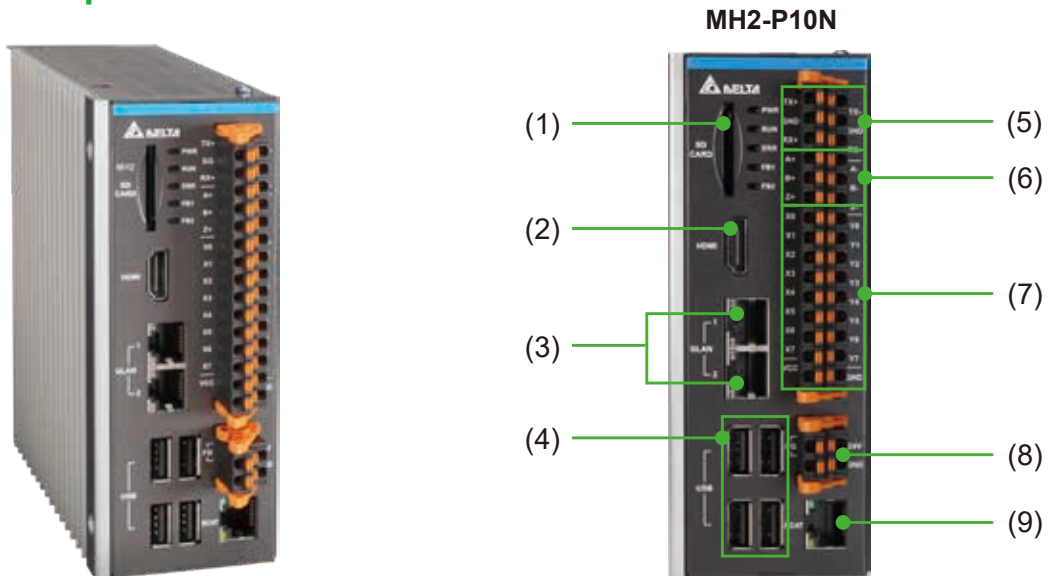

Interface			
(1)	SD Card Slot	(6)	Encoder Input Port
(2)	HDMI Output Terminal	(7)	I/O Connector
(3)	Gigabit LAN Port	(8)	Power Connector
(4)	USB 2.0	(9)	EtherCAT COM Port
(5)	RS-422/485 Serial COM Port		

Model Information

MH2 Series

M H 2 - P 1 0 N - N 0 6 D L

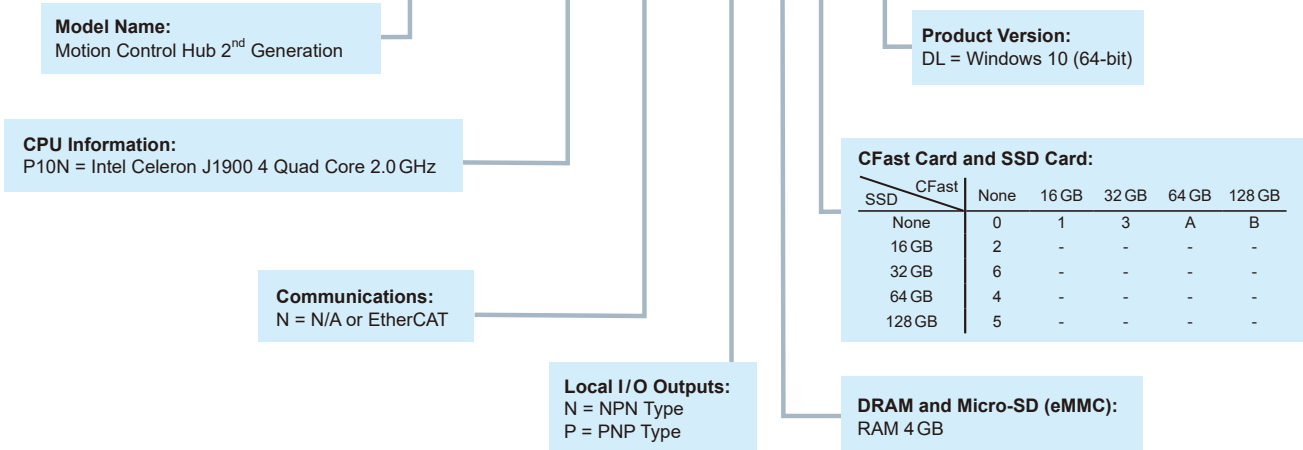

* The model information is for reference only. Please refer to the Ordering Information for details.

Specifications

Model Name	MH2-P10N	
Processor	CPU	Intel Celeron J1900 Quad Core, 2.0 GHz
	BIOS	AMI BIOS
	Memory	Built-in DDR3L-1333 Max. 4 GB
	Nonvolatile Memory	128 kB MRAM
Display	HDMI	HDMI 1.4a × 1
	USB	USB 2.0 × 4
Input / Output	Ethernet	IEEE 802.3/802.3u/802.3ab 1G bps (Intel I210AT) × 2
	Fieldbus	EtherCAT (Intel I210AT) × 1
	Serial Port	Isolated RS-485/RS-422 × 1
	Digital Input	8-CH high-speed isolated input, Sink/Source type, 24 VDC (5 mA/CH)
	Digital Output	8-CH high-speed isolated output, Source type, 24 VDC (200 mA/CH)
	Encoder Input	(Incremental) 1-CH isolated, (EA±/EB±/EZ±) × 1 (Absolute) 1-CH isolated (TX±/RX±) (use RS-422 I/F)
Storage	HDD	M.2 module × 1
	SD Card	SD card slot × 1
MISC.	Security IC	Built-in software system protection security IC × 1
	LEDs	LED display (PWR/RUN/ERR/FB1/FB2) × 5
	Watchdog	Supports Watchdog function
Power Supply Requirement	Input Voltage	DC 24V ± 15%
	Power Consumption	24V/2A/48W
	Power Loss Detection	Low voltage detection and power loss data saving
Mechanism	Installation	Wall-mounted/Slide
	Dimensions	54.2 × 141 × 137.5 mm (W × H × D)
Ambient Environment	Operating Temperature	0°C ~ 50°C
	Storage Temperature	-30°C ~ 85°C
	Relative Humidity	0% ~ 90% RH (Non-condensing)
	Vibration Resistance	2 Grms, IEC 60068-2-64, Random continuous shock, 5 ~ 500 Hz, 1 hr/axis
	Shock Resistance	75G IEC 60068-2-27, Half Sinusoid, Continuous for 11 ms
	Certification	EN 55022 : 2010 · EN 55024 (EN55011 : 2010)
Software	Safety Certification	CE
	Microsoft Windows	Windows 10 IoT 64bit
	Real-time OS	N/A

Note: Please use MH2 for dual-core applications because two cores are used for EtherCAT communication.

Dimensions

MP1-P10D-15 Series

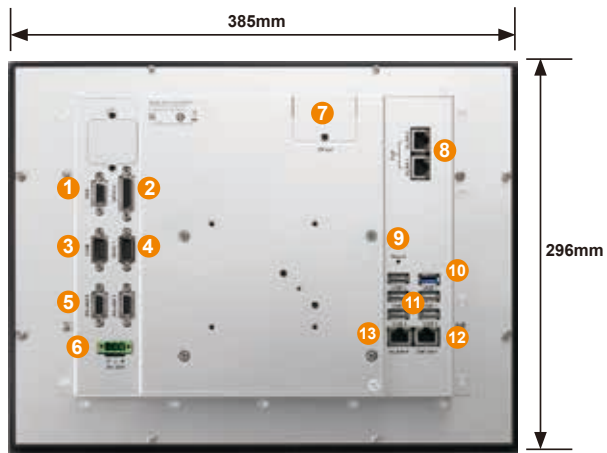

Exterior Description

(1)	VGA Output Connector
(2)	Digital Input/Output Port (12 inputs/12 outputs)
(3)	MPG Input
(4)	Digital Input/Output Port (QEP x 2/CMP x 2)
(5)	RS-485 x 2
(6)	24V Power Input
(7)	CFast Card Slot

(8)	Gigabit LAN Ports x 2
(9)	Reset Switch
(10)	USB 3.0 x 1
(11)	USB 2.0 x 5
(12)	DMCNET Communication
(13)	Gigabit LAN Port x 1

Model Information

MP1Series

M P 1 - P 1 0 D - 1 5 0 A D L

Product Type:
Motion Control Panel 1st Generation

CPU Information:
P10=Intel Celeron J1900 Quad Core 2.0GHz

Communications:
D = DMCNET

Display Size:
15 = 15"

Product Version:
DL=Windows 10(64 bit) +
IMP (IPC Motion Platform)

CFast Card and SSD Card:

SSD	CFast					
	None	16 GB	32 GB	64 GB	128 GB	
None	0	1	3	A	B	
16 GB	2	-	-	-	-	
32 GB	6	-	-	-	-	
64 GB	4	-	-	-	-	
128 GB	5	-	-	-	-	

DRAM and Micro-SD (eMMC):
RAM 4 GB

* The model information is for reference only. Please refer to the Ordering Information for details.

Specifications

Model Name		MP1-P10D-15
Processor System	Processor	Intel Celeron J1900 Quad Core 2.0 GHz
	MRAM	128 KB
	BIOS	AMI BIOS
	System Memory	DDR3L-1333 4 GB
Display Interface	LCD Panel	15" TFT-LCD (262k/ 16.7 M color) 1,024 x 768 pixels (XGA), LED backlight 304.1 (H) x 228.1 (V) mm
	Touch Panel	4-wire Resistive (Max. 10-bit Resolution)
	LED	POWER/RUN/ERROR
	CRT	2,560 x 1,600/60Hz
I/O Interface	Ethernet	IEEE 802.3/802.3u/802.3ab 1 Gbps x 3
	DMCNET	0
	USB	USB 3.0 x 1 USB 2.0 x 5
	Serial Port	isolated RS-422/485 x 2
	Digital Input	1-CH isolated, Sink type, 24 V _{DC} (5 mA / CH) 12-CH isolated, Sink/Source type, 24 V _{DC} (5 mA / CH)
	Digital Output	1-CH isolated, Sink type, 24 V _{DC} (10 mA/CH) 12-CH isolated, Sink type, 24 V _{DC} (200 mA/CH)
Storage	CFast Card	CFast Card (optional) x 1
	eMMC	eMMC (optional) x 1
	Solid State Disk	2.5" SATA SSD (optional) x 1
Power Requirements	Input Voltage	12~30 V _{DC}
	Power Consumption ¹	24 V/3A/72 W
Mechanical	Mounting	Wall-mounting
	Dimensions (W x H x D)	385 x 296 x 55 mm
	Weight	3.18 kg
Environment	Operating Temperature	0°C ~ 50°C
	Storage Temperature	0°C ~ 50°C
	Humidity	0% to 90% RH (non-condensing)
	Vibration Resistance	2 Grms, IEC 60068-2-64, random, 5 ~ 500 Hz, 1 hr/axis
	Shock Resistance	75 G, IEC 60068-2-27, half sine, 11 ms duration
	Safety Certification	CE 
	Windows 10 IoT 64 bit	0

1. Full load power consumption without CFast/SSD or any PCI/PCIe card

EtherCAT Remote Modules

Gateway Type E-bus Remote Power Coupler

R1-EC5500D0

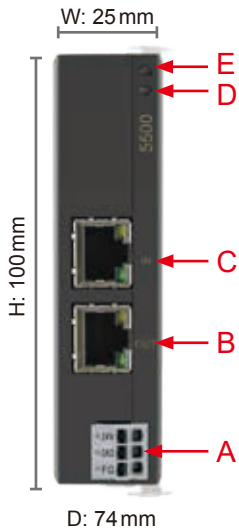

NO.	Description
A.	DC Power Input
B.	EtherCAT Output
C.	EtherCAT Input
D.	Status Indicator
E.	Power Indicator

Technical Data	R1-EC5500D0
Task Within EtherCAT System	Connect EtherCAT Slave module with 100baseTX EtherCAT
Data Transfer Medium	Ethernet/EtherCAT cable (min. CAT 5), shielded
Distance Between Stations	100 M (100BASE-TX) between two slaves
Protocol	EtherCAT
Data Transfer Rates	100 Mbaud
Bus Interface	RJ 45 x 2
Input Voltage	24 V _{DC}
Input Current	50 mA + (E-bus total E-bus current)/4
Current Supply E-Bus	2A
Electrical Isolation	500Vrms (Power contact/Supply voltage/Ethernet)
Vibration/Shock Resistance	EN 60068-2-6/EN 60068-2-27/29
EMC Immunity	ESD (IEC 61131-2, IEC 61000-4-2): 8KV Air Discharge EFT (IEC 61131-2, IEC 61000-4-4): Power Line: 2KV Communication I/O: 1KV RS (IEC 61131-2, IEC 61000-4-3): 80MHz ~ 1 GHz, 10V/m
Operating Environment	Operating temperature: 0 °C ~ 50 °C Storage temperature: -20 °C ~ 70 °C
Weight	55g
Protection Class	IP20
Safety Certification	CE 
Mounting Type	DIN-rail

1-Channel Pulse Output Remote Module

R1-EC5621D0

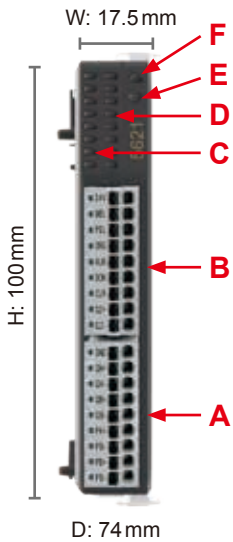

NO.	Description	No.	Description
A.	I/O Signal Port	D.	I/O Signal Indicator
B.	I/O Signal Port	E.	Status Indicator
C.	I/O Signal Indicator	F.	Power Indicator

Input	Description	Input	Description
24V	24V Power	GND	External Ground
MEL	End Limit (-)	QA+	Encoder A Phase (+)
PEL	End Limit (+)	QA-	Encoder A Phase (-)
ORG	Home Signal	QB+	Encoder B Phase (+)
ALM	Servo Alarm	QB-	Encoder B Phase (-)
SON	Servo On	PA+	Pulse Signal (+)
CLR	Reset Servo Alarm	PA-	Pulse Signal (-)
QZ+	Encoder Z Phase (+)	PB+	Dir. Signal (+)
QZ-	Encoder Z Phase (-)	PB-	Dir. Signal (-)

Technical Data	R1-EC5621D0
Number of Outputs	1 channel (PA+, PA-, PB+, PB-)
Number of Inputs	1 channel (QA+, QA-, QB+, QB-, QZ+, QZ-)
Power Supply	Supplied by E-bus
Signal Voltage	RS422 standards
Max. Output Current	RS422 standards
Base Frequency	1Hz ~ 4MHz
Numbers of 24V Input	4 (MEL, PEL, ORG, ALM)
Numbers of 24V Output	2 (CLR, SON)
Trigger Voltage (On > Off)	< 8V _{DC}
Trigger Voltage (Off > On)	> 16.5V _{DC}
Maximum Current of Each Output Port	30mA
Current Consumption E-Bus	150mA
Electrical Isolation	500Vrms (E-bus/field potential)
Bit Width in the Process Image	32 byte in/out (1 x 16 byte data, 1 x 16 byte control/status)
Vibration/Shock Resistance	EN 60068-2-6/EN 60068-2-27/29
EMC Immunity	ESD (IEC 61131-2, IEC 61000-4-2): 8KV Air Discharge EFT (IEC 61131-2, IEC 61000-4-4): Power Line: 2KV Communication I/O: 1KV RS (IEC 61131-2, IEC 61000-4-3: 8MHz ~ 1GHz, 10V/m)
Operating Environment	Operating temperature: 0°C ~ 50°C Storage temperature: -20°C ~ 70°C
Weight	Approx. 60g
Protection Class	IP20
Safety Certification	CE 
Mounting Type	DIN-rail

EtherCAT Remote Modules

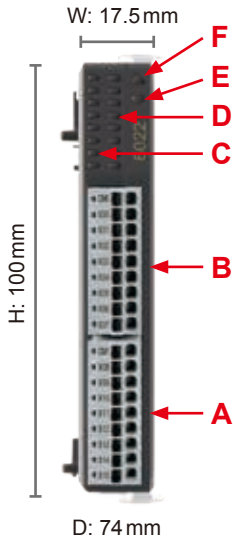

16-Channel Input Remote Module

R1-EC6002D0 / R1-EC6022D0



NO	Description	NO.	Description
A.	Port 1 Terminals	D.	Port 1 I/O Signal X08~X15(From the top)
B.	Port 0 Terminals	E.	Status Indicator
C.	Port 0 I/O Signal X00~X07 (From the top)	F.	Power Indicator

Input	Description	Input	Description
CM0	Port 0 COM	CM1	Port1 COM
X00	Input 0	X08	Input 8
X01	Input 1	X09	Input 9
X02	Input 2	X10	Input 10
X03	Input 3	X11	Input 11
X04	Input 4	X12	Input 12
X05	Input 5	X13	Input 13
X06	Input 6	X14	Input 14
X07	Input 7	X15	Input 15

Technical Data	R1-EC6002D0	R1-EC6022D0
Connection Technology	single-ended	
Number of Inputs	16	
Nominal Voltage	24V _{DC} ± 10%	
Signal Type	SINK/SOURCE	
Trigger Voltage (On > Off)	< 8V _{DC}	
Trigger Voltage (Off > On)	> 16.5V _{DC}	
Input Filter	100 μs	2ms
Input Current	3mA at each port	
Current Consumption E-Bus	110mA	
Electrical Isolation	500 V _{rms} (E-bus/field potential)	
Bit Width in the Process Image	16 inputs	
Vibration/Shock Resistance	EN 60068-2-6/EN 60068-2-27/29	
EMC Immunity	ESD (IEC 61131-2, IEC 61000-4-2): 8KV Air Discharge EFT (IEC 61131-2, IEC 61000-4-4): Power Line: 2KV Communication I/O: 1KV RS (IEC 61131-2, IEC 61000-4-3): 80MHz ~ 1GHz, 10V/m	
Operating Environment	Operating temperature: 0°C ~ 50°C Storage temperature: -20°C ~ 70°C	
Weight	55g	
Protection Rating	IP20	
Safety Certification	 	
Mounting Type	DIN-rail	

16-Channel Output Remote Module

R1-EC7062D0/R1-EC70E2D0/R1-EC70A2D0/R1-EC70F2D0

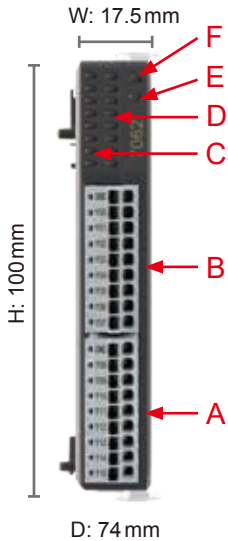



NO.	Description	NO.	Description
A.	Port 1 Terminals	D.	Port 1 I/O Signal Y08~Y15(From the top)
B.	Port 0 Terminals	E.	Status Indicator
C.	Port 0 I/O Signal Y00~Y07(From the top)	F.	Power Indicator

Output	Description	Output	Description
GND*	Port 0 GND	GND	Port 1 GND
24V**	Port 0 24V Input		
Y00	Input 0	Y08	Input 8
Y01	Input 1	Y09	Input 9
Y02	Input 2	Y10	Input 10
Y03	Input 3	Y11	Input 11
Y04	Input 4	Y12	Input 12
Y05	Input 5	Y13	Input 13
Y06	Input 6	Y14	Input 14
Y07	Input 7	Y15	Input 15

* R1-EC7062D0/R1-EC70E2D0

** R1-EC70A2D0/R1-EC70F2D0

Technical Data	R1-EC7062D0	R1-EC70E2D0	R1-EC70A2D0	R1-EC70F2D0
Connection Technology	MOSFET			
Signal Type	SINK		SOURCE	
Nominal Voltage	24V _{DC}			
User-defined Output Disconnection	X	✓	X	✓
Input Current	0.5A (Max.)	0.25A (Max.)		
Current Consumption E-Bus	120mA	200mA		
Response Time/Frequency	1 kHz			
Trigger Time (OFF > ON)	140 μs		160 μs	
Trigger Time (ON > OFF)	150 μs		110 μs	
EMC Immunity	ESD (IEC 61131-2, IEC 61000-4-2): 8KV Air Discharge EFT (IEC 61131-2, IEC 61000-4-4): Power Line: 2KV Communication I/O: 1KV RS (IEC 61131-2, IEC 61000-4-3): 80MHz ~ 1GHz, 10V/m			
Operating Environment	Operating temperature: 0°C ~ 50°C Storage temperature : -20°C ~ 70°C			
Weight	Approx. 60g			
Protection Rating	IP20			
Safety Certification	 			
Mounting Type	DIN-rail			

EtherCAT Remote Modules

4-Channel Analog Input Remote Module

R1-EC8124D0

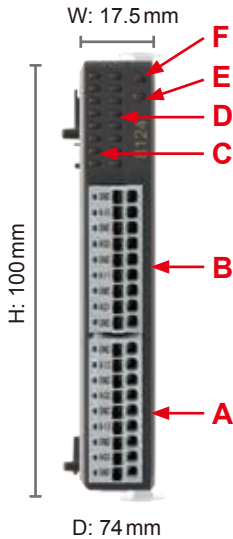

NO.	Description	NO.	Description
A.	CH3/CH4 Signal Port	D.	CH3/CH4 Signal Indicator
B.	CH1/CH2 Signal Port	E.	Status Indicator
C.	CH1/CH2 Signal Indicator	F.	Power Indicator

Input	Description	Input	Description
GND	Analog Ground	GND	Analog Ground
AI0	CH1 Voltage/Current Input	AI2	CH3 Voltage/Current Input
GND	Analog Ground	GND	Analog Ground
AG0	CH1 Current COM*	AG2	CH3 Current COM*
GND	Analog Ground	GND	Analog Ground
AI1	CH2 Voltage/Current Input	AI3	CH4 Voltage/Current Input
GND	Analog Ground	GND	Analog Ground
AG1	CH2 Current COM*	AG3	CH4 Current COM*
GND	Analog Ground	GND	Analog Ground

* In current mode: please connect current COM to GND ; In voltage mode: please disconnect this COM

Technical Data	R1-EC8124D0
Number of Inputs	4 (single-ended)
Power Supply	Supplied by E-bus
Signal Voltage	$\pm 10V / \pm 5V$
Internal Resistance	$> 1M\Omega$
Input Filter Limit Frequency	1 kHz ~ 10 kHz
Resolution	16 bit
Over Sampling Rate	0 ~ 64
Conversion Time	$2\mu s \sim 191\mu s$ (depends on Over Sampling Rate)
Measuring Error	$< \pm 0.2\%$ (relative to full scale value)
Electrical Isolation	1,000Vrms (E-bus/signal voltage)
Current Consumption E-Bus	300 mA
Bit Width in the Process Image	Input: 4 x 16 byte data, 4 x 16 byte control/status
Vibration/Shock Resistance	60068-2-6/EN 60068-2-27/29
EMC Immunity	ESD (IEC 61131-2, IEC 61000-4-2): 8KV Air Discharge EFT (IEC 61131-2, IEC 61000-4-4): Power Line: 2KV Communication I/O: 1KV RS (IEC 61131-2, IEC 61000-4-3): 8MHz ~ 1GHz, 10V/m
Operating Environment	Operating temperature: $0^{\circ}C \sim 50^{\circ}C$ Storage temperature: $-20^{\circ}C \sim 70^{\circ}C$
Weight	Approx. 60g
Protection Rating	IP20
Safety Certification	CE
Mounting Type	DIN-rail

4-Channel Analog Output Remote Module

R1-EC9144D0

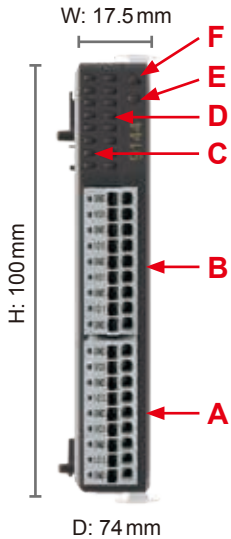

NO.	Description	NO.	Description
A.	CH3/CH4 Signal Port	D.	CH3/CH4 Signal Indicator
B.	CH1/CH2 Signal Port	E.	Status Indicator
C.	CH1/CH2 Signal Indicator	F.	Power Indicator

Output	Description	Output	Description
GND	Analog Ground	GND	Analog Ground
VO0	CH1 Voltage Output	VO2	CH3 Voltage Output
GND	Analog Ground	GND	Analog Ground
IO0	CH1 Current Output	IO2	CH3 Current Output
GND	Analog Ground	GND	Analog Ground
VO1	CH2 Voltage Output	VO3	CH4 Voltage Output
GND	Analog Ground	GND	Analog Ground
IO1	CH2 Current Output	IO3	CH4 Current Output
GND	Analog Ground	GND	Analog Ground

Technical Data	R1-EC9144D0
Number of Inputs	4 (single-ended)
Power Supply	Supplied by E-bus
Signal Voltage Output	$\pm 10V / \pm 5V / 0 \sim 5V / 0 \sim 10V$
Current Output	$0 \sim 20\text{mA} / 4 \sim 24\text{mA} / 0 \sim 24\text{mA}$
Load	$> 1\text{k}\Omega$ (short-circuit-proof)
Resolution	16 bit
Conversion Time	$80\ \mu\text{s}$
Measuring Error	$< \pm 0.2\%$ (relative to full scale value) voltage output $< \pm 0.3\%$ (relative to full scale value) current output
Electrical Isolation	$1,000\text{Vrms}$ (E-bus/signal voltage)
Current Consumption E-Bus	550 mA
Bit Width in the Process Image	Output: 4 x 16 byte, (4 x 16-bit analog output)
Vibration/Shock Resistance	EN 60068-2-6/EN 60068-2-27/29
EMC Immunity	ESD (IEC 61131-2, IEC 61000-4-2): 8 KV Air Discharge EFT (IEC 61131-2, IEC 61000-4-4): Power Line: 2 KV Communication I/O: 1 KV RS (IEC 61131-2, EC 61000-4-3): 8 MHz \sim 1 GHz, 10V/m
Operating Environment	Operating temperature: $0^\circ\text{C} \sim 50^\circ\text{C}$ Storage temperature: $-20^\circ\text{C} \sim 70^\circ\text{C}$
Weight	Approx. 60 g
Protection Rating	IP20
Safety Certification	CE 
Mounting Type	DIN-rail

EtherCAT Remote Modules

Manual Pulse Generator (MPG) Module

R1-EC5614D0

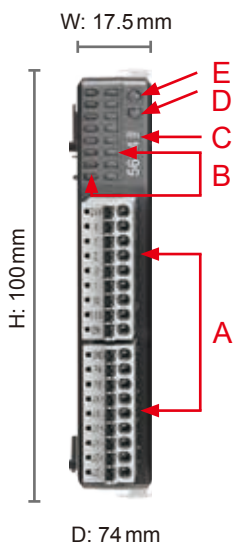

NO.	Description	NO.	Description
A.	IO Signal Port	D.	Status Indicator
B.	I/O Signal Indicator	E.	Power Indicator
C.	Product No.		

Input	Description	Input	Description
GND	External Ground	24V	External Power Input
PA	MPG Pulse Phase A Input	X	X-axis Pulse Chosen Signal
PB	MPG Pulse Phase B Input	Y	Y-axis Pulse Chosen Signal
JX+	JOG X-axis Signal (+)	Z	Z-axis Pulse Chosen Signal
JX-	JOG X-axis Signal (-)	U	U-axis Pulse Chosen Signal
JY+	JOG Y-axis Signal (+)	1	Pulse magnification (x 1)
JY-	JOG Y-axis Signal (-)	10	Pulse magnification (x 10)
JZ+	JOG Z-axis Signal (+) / *W-axis	100	Pulse magnification (x 100)
JZ-	JOG Z-axis Signal (-) / *V-axis	EN	Motion / Setting Execution

*Supports 6-axis MPG via software: JZ+ needs to connect to W-axis signal; JZ- needs to connect to V-axis signal

Technical Data	R1-EC5614D0
Control Axes	4/6 axes
Power Supply	Supplied by E-bus
Pulse Magnification	x1/x10/x100
JOG Input	3/2 sets
Sampling Rate	40kHz
FIFO Length	30 sets
Communication Time	125 μs - 3,276,800 μs
Trigger Time (ON > OFF)	< 8 V _{DC}
Trigger Time (OFF > ON)	> 16.5 V _{DC}
Current Consumption E-Bus	180 mA
Electrical Isolation	500 Vrms (E-bus/Signal Power)
Vibration / Shock Resistance	Compliant with EN 60068-2-6/EN 60068-2-27/29
EMC Immunity	ESD (IEC 61131-2, IEC 61000-4-2) EFT (IEC 61131-2, IEC 61000-4-4) RS (IEC 61131-2, EC 61000-4-3)
Operating Environment	Operating temperature: 0 °C ~ 50 °C Storage temperature: -20 °C ~ 70 °C
Weight	Approx. 55g
Protection Class	IP20
Safety Certification	CE 
Mounting Type	DIN-rail

EtherCAT Remote Modules

Digital Input / Output Module

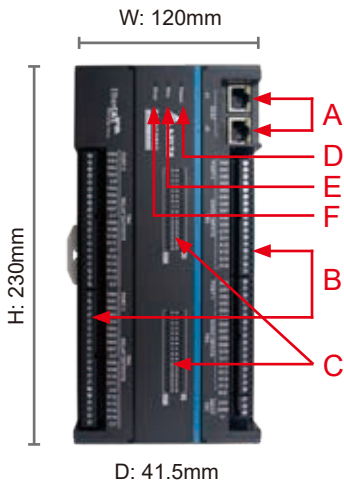

R2-EC0902D0



NO.	Description	NO.	Description
A.	EtherCAT DI/DO Terminals	D.	Power Indicator
B.	GPIO DI/DO Terminals	E.	Communication Indicator
C.	GPIO Status Indicator	F.	Alarm Indicator

DI/DO	Description	DI/DO	Description
X00	Port 0 Input 1	24V	External Power Supply Input
...	...		
X15	Port 0 Input 16		
N.C	Reserved	GND	External Power Ground
X00	Port 1 Input 1	FG	Ground
...	...		
X15	Port 1 Input 16		
S/S*	NPN / PNP Setting		
Y00	Port 2 Input 1		
...	...		
Y15	Port 2 Input 16		
Y00	Port 3 Input 1		
...	...		
Y15	Port 3 Input 16		

*1: S/S: NPN/PNP Setting, NPN = V_{cc}, PNP = GND

Technical Data	R2-EC0902D0	
Nominal Voltage	24 V _{DC} -15% ~+20%	
Input Current	< 1 A	
Digital I/O	Digital Input	Digital Output
Isolation	Optical Coupler	Relay
Signal Type	Sink/Source	A (N.O) Dry Contact
I/O Terminals	32-CH	32-CH
Max. Operating Voltage/Current	30 V _{DC} @ 8mA/Per CH	30 V _{DC} @ 2A/Per CH 250 V _{AC} @ 2A/Per CH
Rated Input Voltage/Current	24 V _{DC} @ 5 mA	-
Frequency	1 kHz	1 Hz
Response Time (Operation) (OFF > ON)	300 μs	10 ms
Response Time (Release) (ON > OFF)	300 μs	5 ms
Relay ON/OFF Times	-	Inductive: 20,000 Times @ 30 V _{DC} 2 A Resistive: 100,000 Times @ 30 V _{DC} , 250 V _{AC} 2 A
Dimensions	230x120x41.5mm (W x H x D)	
Operating Environment	Operating Temperature: 0°C ~ 50°C (32° F ~ 122° F) ; Storage Temperature: -20°C ~ 70°C (-4° F ~ 158° F)	
Mounting Type	DIN-rail	
Vibration / Shock Resistance	Compliant with EN 60068-2-6 / EN 60068-2-27/29	
EMC Immunity	ESD (IEC 61131-2, IEC 61000-4-2) EFT (IEC 61131-2, IEC 61000-4-4) RS (IEC 61131-2, IEC 61000-4-3)	
Protection Rating	IP20	
Safety Certification	 	

DMCNET Remote Modules

Digital Input Remote Modules

- ASD-DMC-RM32MN (32 DI)
- ASD-DMC-RM64MN (64 DI)
- ASD-DMC-RM32PT (16 DI/16 DO)

Electrical Specifications

Model Name	RM32MN / RM64MN / RM32PT
Input Circuit Type	Single common port input
Input Signal Type	SINK / SOURCE
Input Signal Voltage	24 V _{DC} (5mA)
Response Time	0 to 3 ms, adjustable
Action Level (OFF > ON)	> 16.5V _{DC}
Action Level (ON > OFF)	< 8V _{DC}
Noise Tolerance Threshold	ESD (IEC 61131-2, IEC 61000-4-2): 8KV Air Discharge EFT (IEC 61131-2, IEC 61000-4-4): Power Line: 2KV, Communication I/O: 1KV RS (IEC 61131-2, IEC 61000-4-3): 80MHz ~ 1GHz, 10V/m
Environment	Operating Temperature: 0°C ~ 50°C Storage Temperature: -20°C ~ 70°C

Installation & Wiring

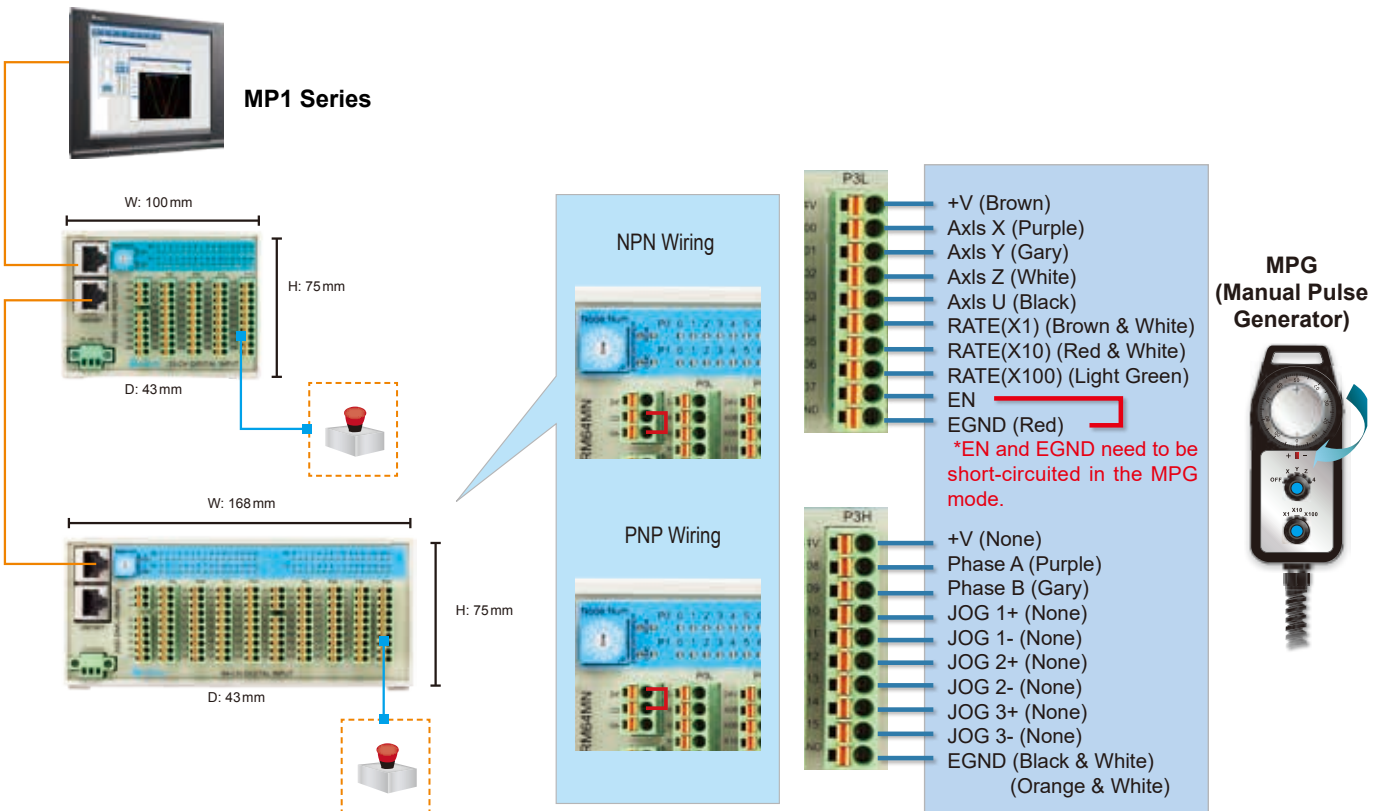

*MPG can only be used for the terminals of P3H and P3L of ASD-DMC-RM64MN.

Digital Output Remote Modules

- ASD-DMC-RM32NT (32 DO)
- ASD-DMC-RM64NT (64 DO)
- ASD-DMC-RM32PT (16 DI/16 DO)
 - Non-volatile memories can be managed through a software API
 - Load Output: 0.1A/1 Point

Electrical Specifications

Model Name	RM32NT/RM64NT
Output Circuit Type	Transistor
Output Signal Type	SINK
Current Specifications	0.1A/1 point
Voltage Specifications	24 V _{DC}
Maximum Switching (Operating) Frequency	1 kHz
Action Level (OFF > ON)	20 μs
Action Level (ON > OFF)	30 μs
Noise Tolerance Threshold	ESD (IEC 61131-2, IEC 61000-4-2): 8 KV Air Discharge EFT (IEC 61131-2, IEC 61000-4-4): Power Line: 2 KV, Communication I/O: 1 KV RS (IEC 61131-2, IEC 61000-4-3): 80 MHz ~ 1 GHz, 10V/m
Environment	Operating Temperature: 0 °C ~ 50 °C Storage Temperature: -20 °C ~ 70 °C

Installation & Wiring

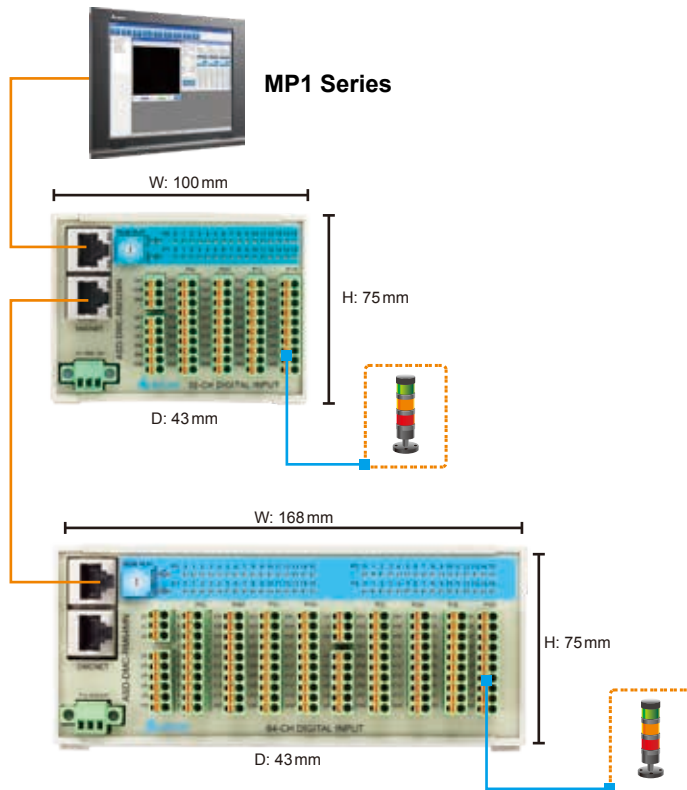

DMCNET Remote Modules

• HMC-RIO3232RT5 (Digital I/O Remote Module)

- 16 points relay type output unit, Max. loading: 2A/1 Point with non-volatile memory function
- 16 points transistor type output unit, Max. loading: 0.1A/1 Point
- 32 points digital input unit – supports SINK and SOURCE modes

Electrical Specifications

Item	HMC-RIO3232RT5
Supply Voltage	24 V _{DC} (15% ~ 20%)
Power Consumption	1.2W
Noise Immunity	RS: Frequency: 80 MHz ~ 1 GHz, 1.4 GHz ~ 2.0 GHz, Test level 10V/m ESD: Contact discharge ±8KV Air discharge ±8KV EFT: ±2KV (Power port), ±2KV (I/O line), Surge: ±2KV (RIO power port)
Temperature	Operating: 0°C ~ 55°C (Temperature), 10 ~ 90% (Humidity); Storage: -20°C ~ 60°C (Temperature), 10 ~ 90% (Humidity)
Vibration	IEC 61131-2 compliant 5 Hz ~ 8.3 Hz = Continuous: 3.5 mm, 8.3 Hz ~ 150 Hz = Continuous: 1.0 g
Shock	IEC 60068-2-27 compliant 15 g peak for 11 ms duration X, Y, Z directions for 6 times
Weight	Approx. 460g

Item	Input Port	Item	Output Port
Input Signal Type	SINK/SOURCE	Output Circuit Type	Transistor/Relay
Input Signal Voltage	24 V _{DC} (5 mA)	Voltage Specifications	24 V _{DC} (-10% ~ +15%) / < 250 V _{AC} (Relay Only)
Input Impedance	4.7K ohm	Current Specifications	100 mA/1 Point (Transistor), 2A/1 Point (Relay), Resistive Load
Action Level	(OFF → ON) > 16.5 V _{DC} (ON → OFF) < 5 V _{DC}	Max. Switching (Operating) Frequency	8 kHz (TR) / 1 Hz (RELAY)
		Response Time	TR: (ON → OFF) : 115 μs, (OFF → ON) : 12 μs RELAY: (ON → OFF) : 10 ms, (OFF → ON) : 10 ms

Installation & Wiring

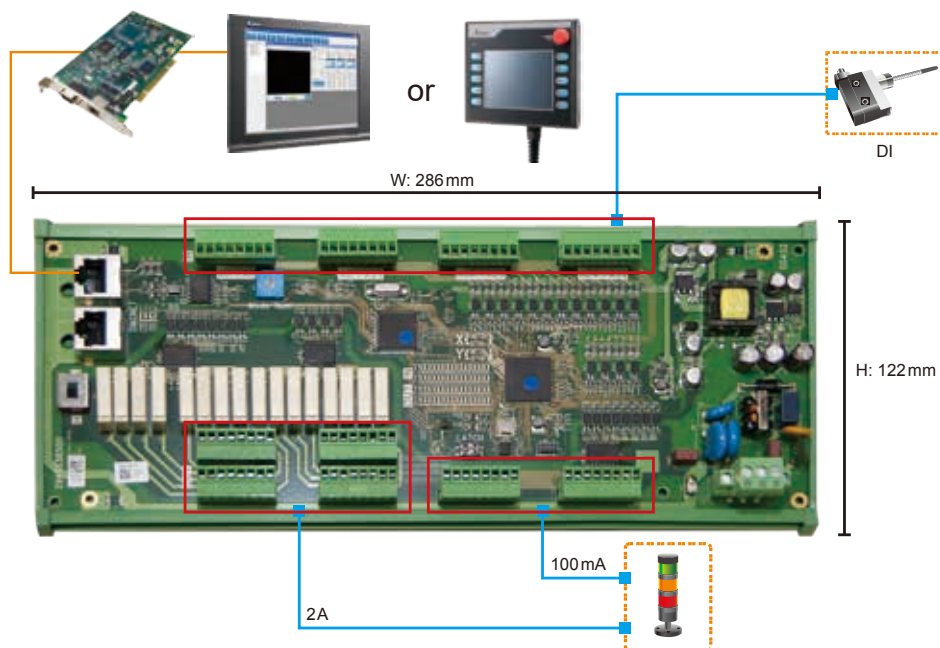

DMCNET Remote Modules

• ASD-DMC-RM04PI (4-Channel Pulse)

- 4 channels of 200 kHz pulse outputs (Pulse +Direction, CCW pulse +CW pulse, A phase + B phase)
- 4 channels of 200 kHz pulse inputs (CCW pulse +CW pulse, A phase + B phase)
- Digital Inputs x8/Digital Outputs x8
- Built-in Positive/Negative Limit and Home for each channel
- In Mode 1, each RM04PI module occupies one node number only, and interpolation motion is carried out within one module.
 - 4 channels occupy 1 node number only
 - 4 channels occupy one PDO and SDO
 - Performs interpolation motion of 4 channels within one RM04PI module only
 - Transfers data in cyclical patterns
 - Motion commands set by parameters
 - Point-to-Point motion mode, motion position calculation is performed within one RM04PI module
- In Mode 2, each RM04PI module occupies node numbers 1~4, which correspond to 4 channels. The interpolation motion can be carried out among different modules.

Electrical Specifications

ASD-DMC-RM04PI	
Item	Input (QA, QB, QZ, DI1, DI2)
Circuit Type	Single
Signal Type	SINK
Power Supply Voltage	5V _{DC}
Work Frequency	QA, QB, QZ: 200 kHz (5mA/1 point) DI1, DI2: 1 kHz (5mA/1 point)
Noise Immunity	ESD (IEC 61131-2, IEC 61000-4-2): 8 KV Air Discharge EFT (IEC 61131-2, IEC 61000-4-4): Power Line: 2KV Communication I/O: 1KV RS (IEC 61131-2, IEC 61000-4-3): 80MHz ~ 1GHz, 10V/m
Operating/Storage Environment	Operating: 0°C ~ 50°C (32°F ~ 122°F) Storage: -20°C ~ 70°C (-4°F ~ 158°F)

ASD-DMC-RM04PI		
Item	Input (MEL, PEL, ORG, SLD)	Output (CW, CCW, DO1, DO2)
Circuit Type	Single	Transistor
Signal Type	SINK / SOURCE	SINK
Power Supply Voltage	24V _{DC} (5mA)	5~24V _{DC} (30mA / 1 point)
Response Time/Work Frequency	1 ms	CW, CCW: 200 kHz DO1, DO2: 1 kHz
Active Level (OFF > ON)	> 16.5V _{DC}	-
Active Level (ON > OFF)	< 8V _{DC}	-
Noise Immunity	ESD (IEC 61131-2, IEC 61000-4-2): 8 KV Air Discharge EFT (IEC 61131-2, IEC 61000-4-4): - Power Line: 2KV - Communication I/O: 1KV RS (IEC 61131-2, IEC 61000-4-3): 80MHz ~ 1GHz, 10V/m	
Operating/Storage Environment	Operating: 0°C ~ 50°C (32°F ~ 122°F) Storage: -20°C ~ 70°C (-4°F ~ 158°F)	

Installation & Wiring

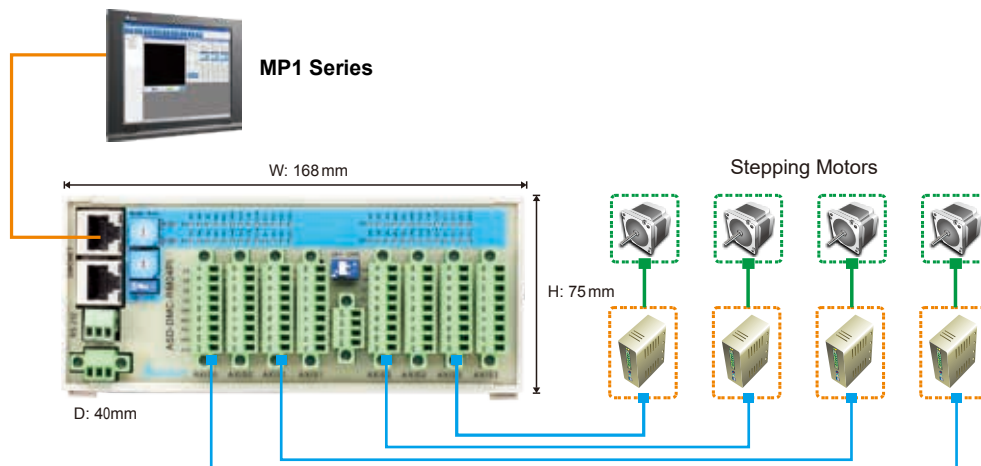

- **ASD-DMC-RM04AD (4-Channel Analog Input)**

Electrical Specifications

ASD-DMC-RM04AD	
Channel	4 Channels/module
Voltage Analog Input Range	-10 ~ 10V/-5 ~ 5V / 0 ~ 10V/0 ~ 5V
Current Analog Input Range	0 ~ 24mA
Digital Conversion Range	0 ~ 65,535
Resolution	16bits
Voltage Input Resistance	140kΩ
Current Input Resistance	249Ω
General Precision	Within ±0.5% (25°C, 77°F) at full scale Within ±1% (0 ~ 55°C, 32 ~ 131°F) at full scale
Response Time	Min. 1 ms/Max. 3 ms × the number of channels.
Isolation	Internal circuit and analog output terminals are isolated with an optical coupler
Voltage Absolute Input Range	-15 ~ 15
Current Absolute Input Range	32mA
Digital Data Format	16 significant bits
Sampling Mode	Five modes which the average number is two (2), four (4), eight (8), sixteen (16) and thirty-two (32) are available for selection.

Installation & Wiring

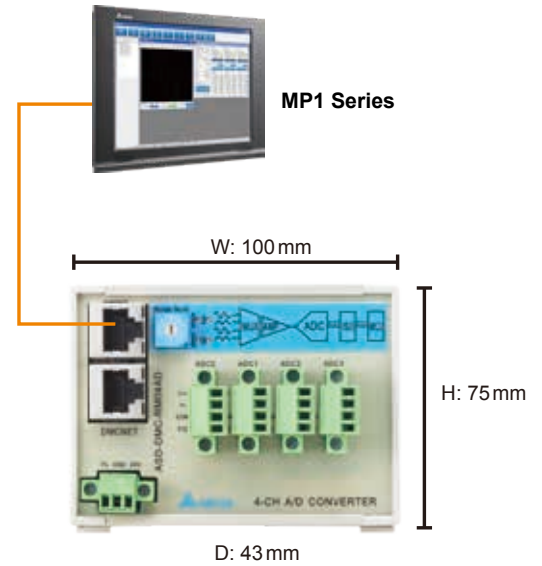

- **ASD-DMC-RM04DA (4-Channel Analog Output)**

Electrical Specifications

ASD-DMC-RM04DA	
Channel	4 Channels/module
Voltage Output Range	-10 ~ 10V/-5 ~ 5V/0 ~ 10V/0 ~ 5V
Current Output Range	0 ~ 24mA/0 ~ 20mA/4 ~ 20mA
Excess Limit (Voltage)	10%
Maximum Output Current (Voltage)	20mA
Allowable Load Resistance (Current)	0 ~ 500Ω
Digital Data Range	0 ~ 4,096
Resolution	16bits
DC Output Resistance	0.3Ω
Response Time	1ms
Digital Data Format	16bits
Isolation	Internal circuit and analog output terminals are isolated with an optical coupler
Protection	Voltage output is protected by short circuit, but must be aware of long-lasting short circuit damaging the internal circuits

Installation & Wiring

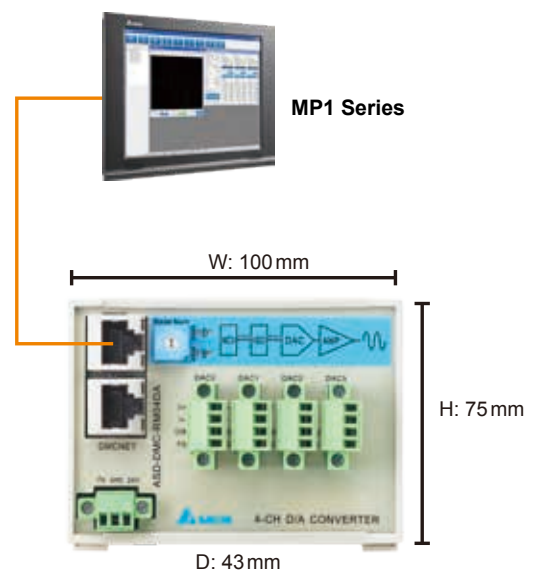

Gateway Type Remote Power Coupler

• Master Module - GA Series



- One GA01 can connect up to a maximum of 4 GE remote modules, of which there may be a maximum of four GE01PH modules.
- One GE01PH module occupies one node number.
- The EzDMC provides a software auto calculation function for calculating the numbers of start and end stations of the ASD-DMC-GA01.

ASD-DMC-GA01 Switching Settings

ADDR1		
PIN	Function	Explanation
1 ~ 12	Start Node Address	Start Station
ADDR2		
PIN	Function	Explanation
1 ~ 12	End Node Address	End Station

There is no communication when the value is set to 0 and 13 ~ 15.
When ADDR1 is set to 1 and ADDR2 is set to 2, it indicates that the remote modules have occupied two stations.

Gateway Type Digital I / O Remote Module

• Slave Module - GE Series

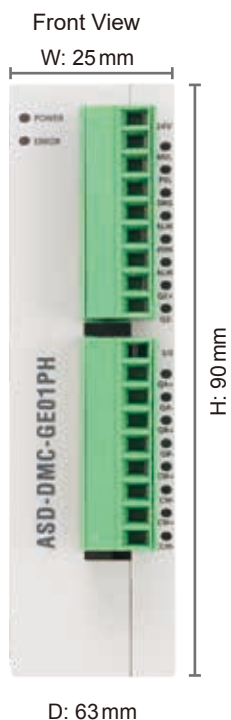

• Gateway Type 1-Channel Pulse Remote Module ASD-DMC-GE01PH

Electrical Specifications

ASD-DMC-GE01PH		
Item	Input	Output
Circuit Type	Single common port input	Transistor
Signal Type	SINK/SOURCE	SINK
Signal Voltage	24 V _{DC} (5 mA)	5 ~ 24 V _{DC} (30 mA/1 point)
Response Time	1 ms	
Maximum Input Pulse Frequency	QA+, QB+, QZ+, QA-, QB-, QZ-: 4 MHz (5 mA/1 point)	CW, CCW: 4 MHz (30 mA/1 point) SVON, RALM: 1 kHz (30 mA/1 point)
Action Level (OFF → ON)	> 16.5 V _{DC}	-
Trigger Level (ON → OFF)	< 8 V _{DC}	-
Output Circuit Type	-	RS-422
Output Signal Type	-	Differential

Ordering Information

Programmable Automation Controllers - Motion Control Host PAC

Model Name	CPU Type	Storage	Slot Interface	RAM	OS	Motion Protocol	Development Tool
MH2-P10N-N04DL	Celeron J1900 Quad Core 2.0GHz	NA	64 GB SSD	4 GB	Win 10 IoT 64 bit	EtherCAT	API

Programmable Automation Controllers - Motion Control Panel PC

Model Name	CPU Type	Storage	Slot Interface	RAM	OS	Motion Protocol	Development Tool
MP1-P10D-150ADL	Celeron J1900 Quad Core 2.0GHz	15"	64 GB CFast 128 GB CFast	4 GB	Win 10 IoT 64 bit	DMCNET	API/IMP
MP1-P10D-150BDL							

Motion Control Cards

PCIE-L221-B1D0	32-axis Advanced EtherCAT Motion Control Card + 2 Sets of Pulse Comparison
PCIE-L221-BF1D0	16-axis Standard EtherCAT Motion Control Card + 2 Sets of Pulse Comparison
PCIE-L221-BF0D0	8-axis Standard EtherCAT Motion Control Card + 2 Sets of Pulse Comparison
PCI-L221-P1D0	EtherCAT Standard Type Motion Control Card
PCI-L221-F1D0	EtherCAT Economic Type Motion Control Card
PCI-L221-F0D0	8-axis Basic EtherCAT Motion Control Card
PCI-L221-B1D0	EtherCAT Advanced Type Motion Control Card with 2 Groups of Pulse Comparison
PCI-L221-BF1D0	16-axis Standard EtherCAT Motion Control Card + 2 Sets of Pulse Comparison
PCI-L221-BF0D0	8-axis Standard EtherCAT Motion Control Card + 2 Sets of Pulse Comparison
PCI-L221-CF1D0	16-axis Standard EtherCAT Motion Control Card + Hand Wheel
PCI-L221-CF0D0	8-axis Standard EtherCAT Motion Control Card + Hand Wheel
PCI-DMC-A02	DMCNET Standard Type Motion Control Card with Local I/O (32 DI/24 DO)
PCI-DMC-B01	DMCNET Advanced Type Motion Control Card with 2 Groups of Pulse Comparison
PCI-DMC-B02	DMCNET Advanced Motion Control Card + 2D Pulse Comparison
PCI-DMC-B03	DMCNET Advanced Motion Control Card + 3 Sets of Pulse Comparison & 10 Sets of DO
PCI-DMC-F02	DMCNET Economic Type Motion Control Card + local IO (32 DI/24 DO)

Ordering Information

EtherCAT Remote Modules	
R1-EC5500D0	E-BUS Remote Power Coupler
R1-EC5621D0	1-Channel Pulse Output Remote Module
R1-EC5614D0	MPG Extension Module
R1-EC6002D0	Digital Input Remote Module (NPN/PNP); response time < 0.1 ms
R1-EC6022D0	Input Remote Module (NPN/PNP); response time 2ms
R1-EC7062D0	Digital Output Remote Module (NPN)
R1-EC70A2D0	Digital Output Remote Module (PNP)
R1-EC70E2D0	Digital Output Remote Module (NPN)
R1-EC70F2D0	Digital Output Remote Module (PNP)
R1-EC8124D0	4-Channel Analog Input Module
R1-EC9144D0	4-Channel Analog Output Module

EtherCAT Remote Modules	
R2-EC0902D0	Digital Input/Output Remote Module with Relay

DMCNET Remote Modules	
ASD-DMC-RM32MN	32 Digital Input Remote Module (NPN/PNP)
ASD-DMC-RM64MN	64 Digital Input Remote Module (NPN/PNP) plus MPG Module
ASD-DMC-RM32NT	32 Digital Output Remote Module
ASD-DMC-RM64NT	64 Digital Output Remote Module
ASD-DMC-RM32PT	32 Digital I/O Remote Module with 16 DI (NPN/PNP) & 16 DO (Transistor Output)
ASD-DMC-RM04PI	4-Channel Pulse Remote Module (4 Channels of 200 kHz Pulse Outputs and Inputs)
ASD-DMC-RM04AD	4-Channel Analog Input Module
ASD-DMC-RM04DA	4-Channel Analog Output Module
HMC-RIO3232RT5	Digital I/O Remote Module with 32 DI (NPN/PNP), 16 DO (Relay Output) & 16 DO (Transistor Output)

DMCNET Gateway Type Remote Modules	
ASD-DMC-GA01	DMCNET Gateway Type Remote Power Coupler
ASD-DMC-GE01PH	DMCNET Gateway Type Pulse Output Remote Module (1-Channel of 4M High-speed Pulse Interface)



Smarter. Greener. Together.

Industrial Automation Headquarters

Taiwan: Delta Electronics, Inc.

Taoyuan Technology Center
No.18, Xinglong Rd., Taoyuan District,
Taoyuan City 33068, Taiwan
TEL: +886-3-362-6301 / FAX: +886-3-371-6301

Asia

China: Delta Electronics (Shanghai) Co., Ltd.

No.182 Minyu Rd., Pudong Shanghai, P.R.C.
Post code : 201209
TEL: +86-21-6872-3988 / FAX: +86-21-6872-3996
Customer Service: 400-820-9595

Japan: Delta Electronics (Japan), Inc.

Industrial Automation Sales Department
2-1-14 Shibadaimon, Minato-ku
Tokyo, Japan 105-0012
TEL: +81-3-5733-1155 / FAX: +81-3-5733-1255

Korea: Delta Electronics (Korea), Inc.

1511, 219, Gasan Digital 1-Ro., Geumcheon-gu,
Seoul, 08501 South Korea
TEL: +82-2-515-5305 / FAX: +82-2-515-5302

Singapore: Delta Energy Systems (Singapore) Pte Ltd.

4 Kaki Bukit Avenue 1, #05-04, Singapore 417939
TEL: +65-6747-5155 / FAX: +65-6744-9228

India: Delta Electronics (India) Pvt. Ltd.

Plot No.43, Sector 35, HSIIDC Gurgaon,
PIN 122001, Haryana, India
TEL: +91-124-4874900 / FAX: +91-124-4874945

Thailand: Delta Electronics (Thailand) PCL.

909 Soi 9, Moo 4, Bangpoo Industrial Estate (E.P.Z),
Pattana 1 Rd., T.Phraksa, A.Muang,
Samutprakarn 10280, Thailand
TEL: +66-2709-2800 / FAX: +66-2709-2827

Australia: Delta Electronics (Australia) Pty Ltd.

Unit 20-21/45 Normanby Rd., Notting Hill Vic 3168, Australia
TEL: +61-3-9543-3720

Americas

USA: Delta Electronics (Americas) Ltd.

5101 Davis Drive, Research Triangle Park, NC 27709, U.S.A.
TEL: +1-919-767-3813 / FAX: +1-919-767-3969

Brazil: Delta Electronics Brazil

Rua Itapeva, 26 - 3º, andar Edifício Itapeva,
One - Bela Vista 01332-000 - São Paulo - SP - Brazil
TEL: +55-12-3932-2300 / FAX: +55-12-3932-237

Mexico: Delta Electronics International Mexico S.A. de C.V.

Gustavo Baz No. 309 Edificio E PB 103
Colonia La Loma, CP 54060
Tlalnepantla, Estado de México
TEL: +52-55-3603-9200

EMEA

EMEA Headquarters: Delta Electronics (Netherlands) B.V.

Sales: Sales.IA.EMEA@deltaww.com
Marketing: Marketing.IA.EMEA@deltaww.com
Technical Support: iatechnicalsupport@deltaww.com
Customer Support: Customer-Support@deltaww.com
Service: Service.IA.emea@deltaww.com
TEL: +31(0)40 800 3900

BENELUX: Delta Electronics (Netherlands) B.V.

Automotive Campus 260, 5708 JZ Helmond, The Netherlands
Mail: Sales.IA.Benelux@deltaww.com
TEL: +31(0)40 800 3900

DACH: Delta Electronics (Netherlands) B.V.

Coesterweg 45, D-59494 Soest, Germany
Mail: Sales.IA.DACH@deltaww.com
TEL: +49(0)2921 987 0

France: Delta Electronics (France) S.A.

ZI du bois Challand 2, 15 rue des Pyrénées,
Lisses, 91090 Evry Cedex, France
Mail: Sales.IA.FR@deltaww.com
TEL: +33(0)1 69 77 82 60

Iberia: Delta Electronics Solutions (Spain) S.L.U

Ctra. De Villaverde a Vallecas, 265 1º Dcha Ed.
Hormigueras – P.I. de Vallecas 28031 Madrid
TEL: +34(0)91 223 74 20

Carrer Llacuna 166, 08018 Barcelona, Spain

Mail: Sales.IA.Iberia@deltaww.com

Italy: Delta Electronics (Italy) S.r.l.

Via Meda 2-22060 Novedrate(CO)
Piazza Grazioli 18 00186 Roma Italy
Mail: Sales.IA.Italy@deltaww.com
TEL: +39 039 8900365

Russia: Delta Energy System LLC

Vereyskaya Plaza II, office 112 Vereyskaya str.
17 121357 Moscow Russia
Mail: Sales.IA.RU@deltaww.com
TEL: +7 495 644 3240

Turkey: Delta Greentech Elektronik San. Ltd. Sti. (Turkey)

Şerifali Mah. Hendem Cad. Kule Sok. No:16-A
34775 Ümraniye – İstanbul
Mail: Sales.IA.Turkey@deltaww.com
TEL: + 90 216 499 9910

MEA: Eltek Dubai (Eltek MEA DMCC)

OFFICE 2504, 25th Floor, Saba Tower 1,
Jumeirah Lakes Towers, Dubai, UAE
Mail: Sales.IA.MEA@deltaww.com
TEL: +971(0)4 2690148