



FEATURES

- Full Load Efficiency up to 93% @220VAC
- Metal Baseplate Type Package
- Package Dimension:
110.8x50.8x13.7mm (4.36"x2.00"x0.54")
- Operating Baseplate Temperature Range - 40°C to +100°C
- Input Brown-Out, Output OCP, OTP, OVP, SHORT protection
- 3000VAC Isolation
- RoHs Compliant
- CE Mark
- EMC compatible: CISPR22 ClassB(with external EMC filter)
- ISO 9001, ISO 14001 certified manufacturing facility
- UL60950-1 (US&Canada)
- Prohibit parallel application

The PACSR28010, a wide input voltage range of 85~265VAC, and single isolated output converter, is the latest product offering from a world leader in power systems technology and manufacturing — Delta Electronics, Inc. Such module type ACDC converter can provide 300W, 28V regulated DC output voltage with full load efficiency up to 93% @220Vac; The PACSR28010 offers Brown-out, output OCP, OTP, OVP and Short protections, and allows a wide operating baseplate temperature range of -40°C to +100°C. With creative design technology and optimization of component placement, this converter possess outstanding electrical and thermal performance, as well as high reliability under extremely harsh operating conditions.

(All specifications valid base on the connection of figure 9, unless otherwise indicated)

INPUT CHARACTERISTICS

Item	Condition	Min.	Typ.	Max.	Unit
Rated Input Voltage range		100	110/220	240	VAC
Max input voltage range		85		265	VAC
Input voltage frequency range		45	50/60	65	Hz
Maximum Input Current	Vin=85VAC, 100% Load			5	A
Open load loss			2.5		W
Input PF value	Vin=110VAC, 100% Load	0.95			
Allowable bus capacitance range (*1)	Vin=110/220VAC 100% Load	440		1000	uF

OUTPUT CHARACTERISTICS

Item	Conditions	Min.	Typ.	Max.	Unit
PG	Vo=28V	3.1	3.2	3.3	V
Output voltage setpoint	Vin=220VAC, Io=0-10.5A	27.6	28	28.4	Vdc
Output current range		0		10.5	A
Output OCP point		11	13.5	16	A
Turn-on rise time			20		ms
Start up time			1000		mS
Hold up time	Vin=110/220VAC, Io= 100% Load		20		mS
Output trim range	Trim up			10	%
	Trim down			5	%
Output OVP point		32	33.5	35	V
Output Current Transient	Positive voltage step, 75% to 25% load dynamic, 0.1A/us slew rate		400	600	mV
	Negative voltage step, 25% to 75% load dynamic, 0.1A/us slew rate		400	600	mV



Output Voltage Ripple and Noise	Vin=110/220Vac, Io=10.5A, peak to peak, 20MHz bandwidth		100		mV
	RMS		50		mV
Output overshoot				3	%
Efficiency @ 60% Load	Vin=110VAC		90		%
Efficiency @ 60% Load	Vin=220VAC		91		%
Efficiency @ 100% Load	Vin=110VAC		91.5		%
Efficiency @ 100% Load	Vin=220VAC		93		%
Allowable output capacitance range (*2)	Vin=110/220VAC, Io= 100% Load	1080		5000	uF

GENERAL CHARACTERISTICS

Item	Conditions	Min.	Typ.	Max.	Unit
I/O Isolation Voltage	Input to output		3000		VAC
	Input to case		1500		VAC
	Output to case		500		VAC
I/O Isolation Resistance	500Vdc	10			MΩ
MTBF	Ta=25°C, 100%load		TBD		Mhours
Weight			240		g

ENVIRONMENTAL SPECIFICATIONS

Parameter	Conditions	Min.	Max.	Unit
Storage Temperature Range		-55	+125	°C
Operating Temperature Range	Baseplate Temperature	-40	+100	°C
Operating altitude			3000	meter

ELECTRICAL CURVE

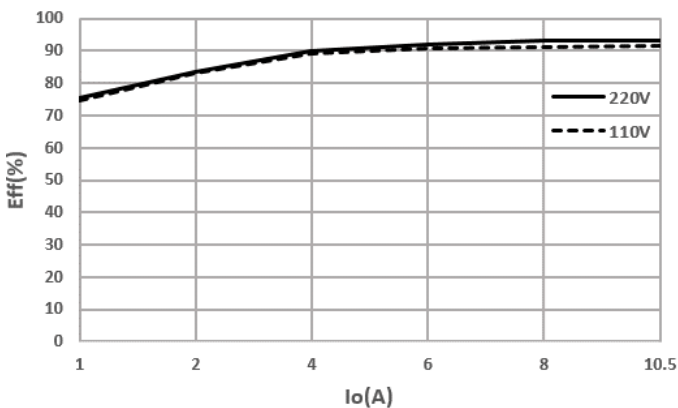

Figure 1: Efficiency vs. Output current @ Vin=110,220VAC

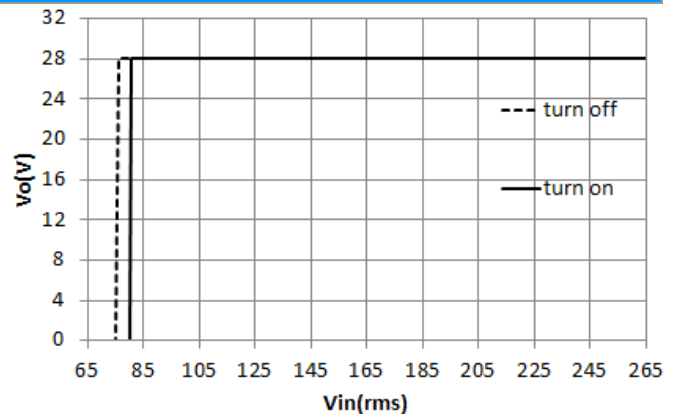

Figure 2: Vout vs. Vin @ Full load

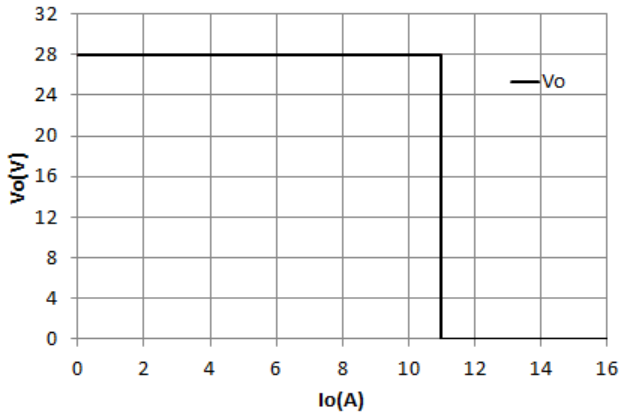

Figure 3: Output voltage vs. Output current @ $V_{in}=110/220VAC$.

ELECTRICAL CURVES (continous)



Figure 4: Dynamic response to load step 25%~75% with $0.1A/\mu S$ slew rate at 220Vac
TOP: VOUT, 200mV/div, BOTTOM: Iout, 5A/div, 200uS/div

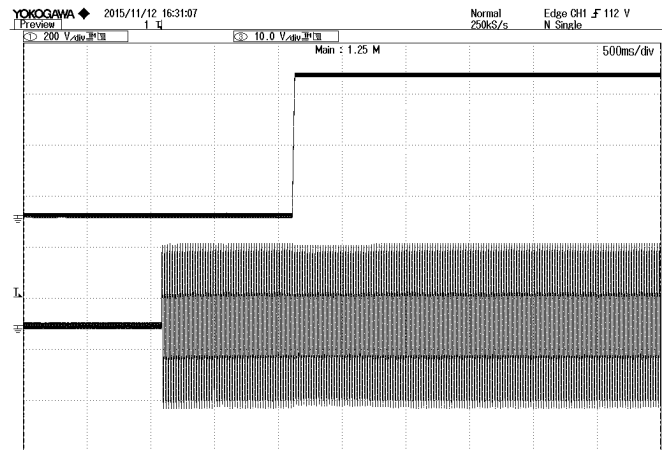
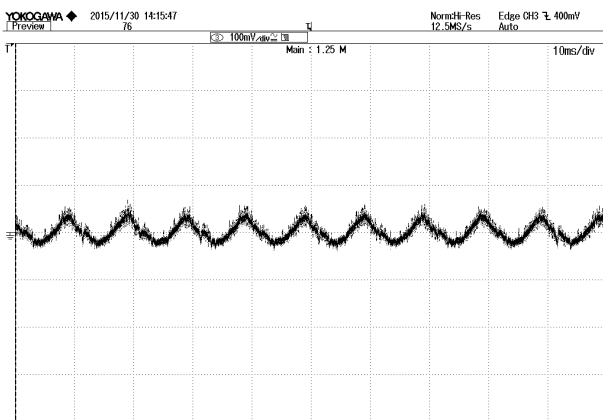

Figure 5: Vout start up at 220Vac, 10.5A Iout,
TOP: VOUT, 10V/div, 500mS/div
BOTTOM: Vin, 200V/div, 500mS/div



P-P(C3) 110.0mV

Figure 6: Output ripple & noise at 220Vac, 10.5A Iout
VOUT: 100mV/div, 10mS/div

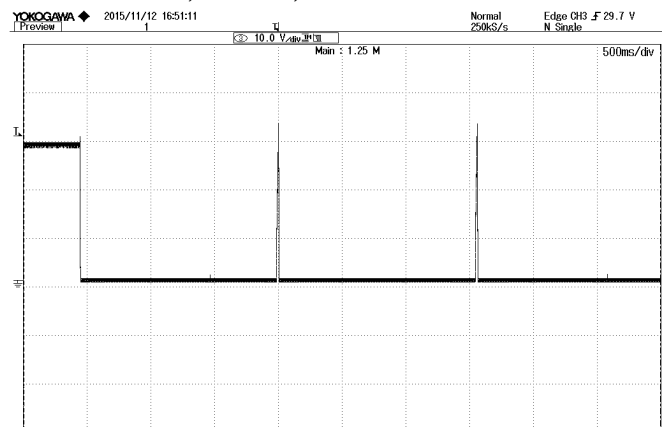

Figure 7: Output over voltage protection at 220Vac, 10.5A Iout. VOUT: 10V/div, 500mS/div

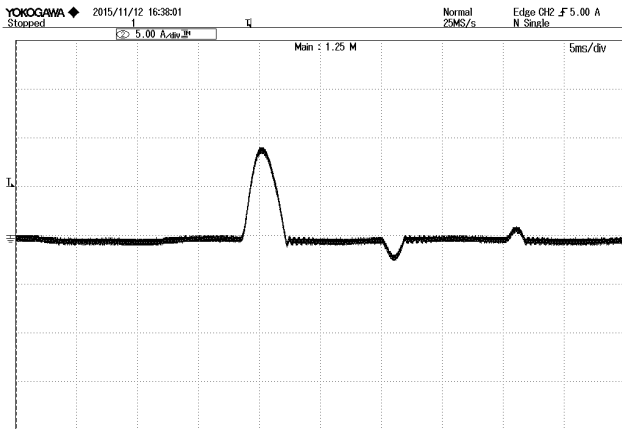

Figure 8: Inrush current @ Vin=220Vac lin: 5A/div, 5mS/div

SIMPLIFIED APPLICATION CIRCUIT

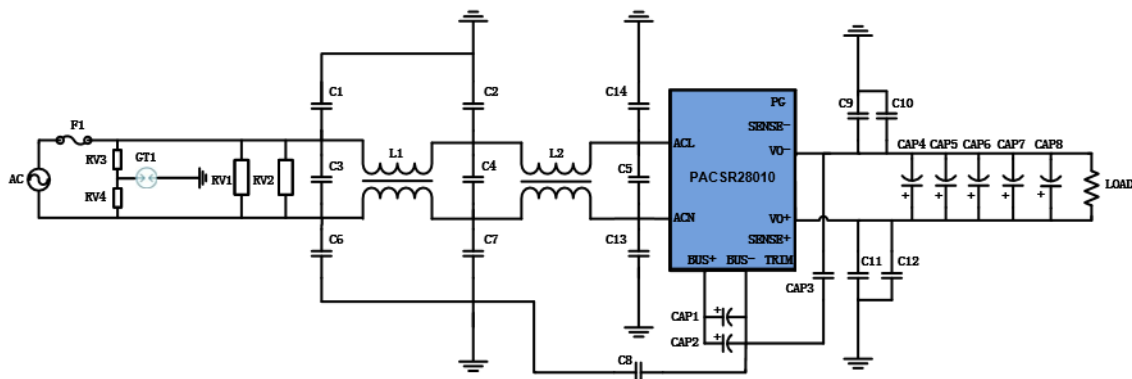

Figure 9: Application connection

TYPICAL value ADVISED

No	Locati on	item	value	Part No
1	Cap1	bus cap	220uF/450V	Capacitor should have good low-temperature characteristics, keep at least 75% capacitance at -40°C if need -40C application. (*3)
2	Cap2	bus cap	220uF/450V	
3	Cap3	Cap for pri-sec	2200pF/250Vac Y1/X1	
4	Cap4	Output cap	1000uF/35V	ESR ≤ 16m Ω (100kHz), Rated ripple ≥ 2920mArms(105°C) (*4)
5	Cap5	Output cap	270uF/35V	ESR ≤ 17m Ω (100kHz), Rated ripple ≥ 2200mArms(125°C) (*5)
6	Cap6	Output cap	270uF/35V	
7	Cap7	Output cap	270uF/35V	
8	Cap8	Output cap	270uF/35V	
9	F1	Input Fuse	6.3A/250Vac	
10	RV1	Input VDR	300VAC	TVR14471K000TB9Y/THINKING
11	RV2	Input VDR	300VAC	TVR14471K000TB9Y/THINKING
12	RV3	Input VDR	300VAC	TVR14471K000TB9Y/THINKING
13	RV4	Input VDR	300VAC	TVR14471K000TB9Y/THINKING

No	Location	item	value	Part No
14	GT1	Input GAS TUBE	2.5KV/10KA	B88069X8661S102(EF2500X8S)
15	C1	Input Y-cap	100pF/250Vac Y2/X1	
16	C2	Input Y-cap	4700pF/250Vac Y2/X1	
17	C3	Input X-cap	1uF /305VAC X2	
18	C4	Input X-cap	0.47uF /275VAC X2	
19	C5	Input X-cap	0.47uF /275VAC X2	
20	C6	Input Y-cap	100pF/250Vac Y2/X1	
21	C7	Input Y-cap	4700pF/250Vac Y2/X1	
22	C8	Cap for pri-PE	1500pF/250Vac Y1/X1	
23	C9	output Y-cap	4700pF/250Vac Y2/X1	
24	C10	output Y-cap	4700pF/250Vac Y2/X1	
25	C11	output Y-cap	4700pF/250Vac Y2/X1	
26	C12	output Y-cap	4700pF/250Vac Y2/X1	
27	C13	Input Y-cap	100pF/250Vac Y2/X1	
28	C14	Input Y-cap	100pF/250Vac Y2/X1	
29	L1	Input chock	6.5mH ϕ 1mm	PH9455.705NL/Pulse Electronics
30	L2	Input chock	6.5mH ϕ 1mm	

*read the Application Note for this module carefully before using the power supply unit

=Note=

*1 and *3 . About the bus cap, pls read the Application Note about the hold up time configure.

*2 and *5. About the min output cap, pls use the cap which has more performance than the cap in the table above, or refer the cap about the output cap ability in the Application Note.

*2 and *4. About the max output cap, pls follow the Application Note about the output cap ability.

THERMAL CONSIDERATION

Thermal management is an important part of the system design. To ensure proper, reliable operation, sufficient cooling of the power module is needed over the entire temperature range of the module. Natural convection is usually the dominant mode of heat transfer.

Thermal Testing Setup

The following figure shows the testing setup in which the power module is mounted on a 250x300x5mm test Al plate, under natural convection.

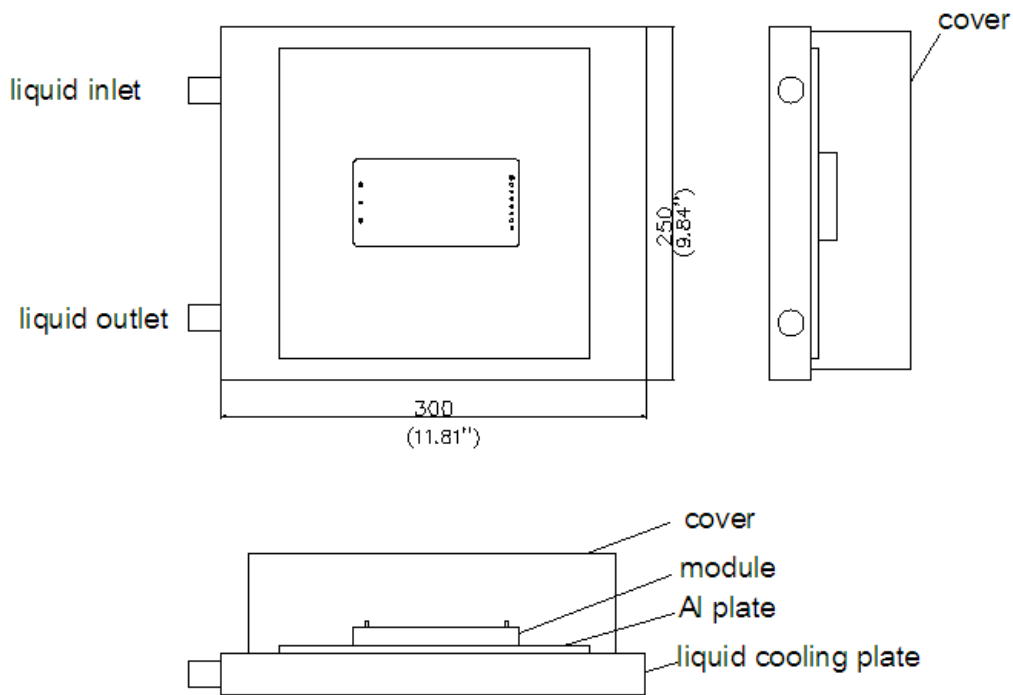

Figure 10: Thermal test setup

THERMAL DERATING CURVE

The following figure shows the location to monitor the temperature of base plate. Before customer decides to use this, a thermal evaluation need to be done to make sure the temperature of base plate is lower than that read from below thermal curves (Figure11 is based on different input voltage).

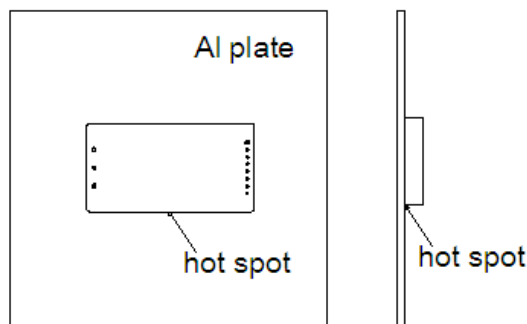

Figure 11: Hot spot's temperature measured point

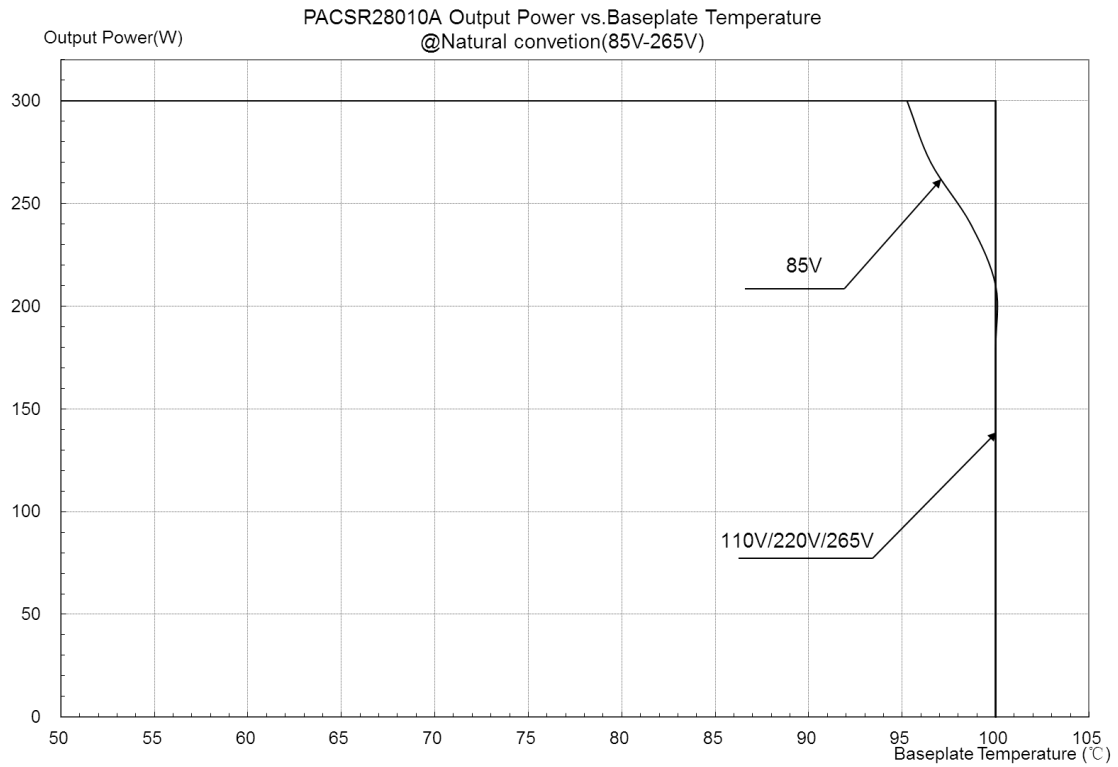
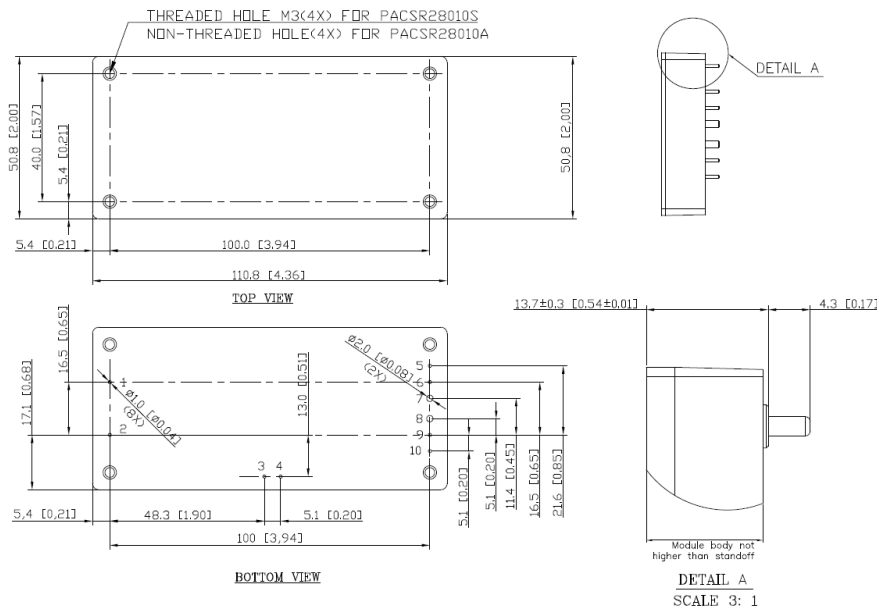

Figure 12: Thermal derating curve

MECHANICAL DRAWING

Mechanical Dimensions



Pin Connection

Pin	Function
1	ACL
2	ACN
3	BUS+
4	BUS-
5	PG
6	SENSE-
7	VOU-
8	VOU+
9	SENSE+
10	TRIM

All dimensions in mm (inches)
Tolerance: X.X±0.5 (X.XX±0.02)
X.XX±0.25 (X.XXX±0.010)

PHYSICAL OUTLINE

Case Size	: 110.8x50.8x13.7mm (4.36"x2.00"x0.54")
Case Material	: AL plate and Plastic case
Weight	: 240±10g

PART NUMBERING SYSTEM

P	AC	S	R	28	010	A
Form Factor	Rated Input Voltage	Number of Outputs	Product Series	Output Voltage	Output Current	Option Code
P - Module	AC - 100VAC~240VAC	S - Single	R - Regular	28V	10.5A	A - Through hole S - Screw hole(M3*0.5)

RECOMMENDED PART NUMBER

Model Name	Rated Input	Output	EFF @220VAC 100% LOAD
PACSR28010A	100VAC~240VAC 3.8A	28V 10.5A	93%
PACSR28010S	100VAC~240VAC 3.8A	28V 10.5A	93%

WARRANTY

Delta offers a three (3) years limited warranty. Complete warranty information is listed on our web site or is available upon request from Delta.

Information furnished by Delta is believed to be accurate and reliable. However, no responsibility is assumed by Delta for its use, nor for any infringements of patents or other rights of third parties, which may result from its use. No license is granted by implication or otherwise under any patent or patent rights of Delta. Delta reserves the right to revise these specifications at any time, without notice.